

**WACKER**

CREATING TOMORROW'S SOLUTIONS

HEALTHCARE | MEDICAL TECHNOLOGY

# SILICONES FOR MEDICAL TECHNOLOGY

ELASTOSIL®

SILPURAN®



# HEALTH. CARE. WACKER.



We care. And that's why we keep researching and developing medical solutions that improve quality of life. In applications such as medical devices, accessories and medical as well as pharma tubing, you will feel the difference with our innovative silicones. Our experienced WACKER team knows how to find the right solution to the challenge of your specific product.

[More information](#)

[www.wacker.com/healthcare](http://www.wacker.com/healthcare)



2





# WACKER SILICONE ELASTOMERS – ANSWERS TO THE MEDICAL QUESTIONS OF TOMORROW

Regardless of the challenges the future holds, ELASTOSIL® and SILPURAN® offer you future-proof solutions that satisfy the highest standards.

The average age of the population is increasing steadily. At the same time, more and more people are gaining access to modern healthcare, resulting in increasingly strict legal requirements for medical products and services. As a result, the healthcare industry faces ever-increasing demands with regard to the safety and efficiency of its solutions. WACKER has responded to this development with silicone products from its ELASTOSIL® and SILPURAN® lines: future-proof silicone elastomers for the most exacting standards.

As a global market leader for silicone elastomers, WACKER's strength lies both in its unique expertise and

pioneering research, and in its integrated raw-materials system. That means customers can trust in future-proof solutions that meet the highest German quality standards.

Much more than just two product lines: ELASTOSIL® and SILPURAN® always stand for the best service available, ensuring your success. Our teams of experts are always ready to help you exploit the virtually unlimited flexibility and innovative strength of these products so that they best meet your needs. The resulting customized solutions will help secure lasting success for your business.

**Please note that the WACKER SILICONES HEALTH CARE POLICY limits the use of WACKER silicones for certain medical applications and excludes use for longterm implants. More information on this topic can be found on our website: [www.wacker.com](http://www.wacker.com)**

## Interesting Facts About Silicones

Silicones are modern synthetic materials, whose versatile performance is due to their chemical structure and the many different ways they can be modified.

Thanks to the high energy of the Si-O bond, silicones do an excellent job of resisting the elements. Silicones stand for chemical resistance, thermal stability and outstanding mechanical properties.

- The term “silicone” was coined by F. S. Kipping (1863–1949)
- Silicones consist of a polymer backbone built of alternating silicon and oxygen atoms

- In nature, silicon occurs exclusively in the form of silicon dioxide and silicates
- Silicon is the second most abundant element in the earth's crust (26 percent by weight)
- The energy of a Si-O bond is significantly greater than that of a C-C bond
- The thermal and oxidative stability of silicones is higher than that of most organic plastics and rubber
- Silicones are highly resistant to UV,  $\beta$  and  $\gamma$  radiation





# AS VERSATILE AS MODERN MEDICINE



Their special property profile makes ELASTOSIL® and SILPURAN® silicone elastomers ideal for medical applications. Just three of the many reasons for using these pure materials are that they can be sterilized and offer excellent chemical and physical resistance with no need for additional stabilizers.

Extrudable solid silicone rubber compounds are extremely tear resistant, highly elastic and remarkably resilient at the same time. They are used in numerous pharmaceutical and medical tubing applications, such as drainage, breathing and feeding tubes, urinary catheters and tubes for fluid transfer or in peristaltic pumps.

Solid silicone rubber compounds provide excellent mechanical properties, are very durable, serve as good elastic sealing materials and are soft and

pleasing to the touch. They can be processed via injection, compression and transfer molding.

Applications range from seals, valves, septa, filters and membranes (such as those in syringe seals or membranes for needle-free injection systems), to respirators and respiratory bellows, handles for equipment and instruments or mats for sterilization trays.

ELASTOSIL® and SILPURAN® liquid silicone rubber enable the economical production of injection molded parts in large scale. Such parts are e.g. used as seals, bellows or membranes and in needle-free valves.

Their high level of transparency enables a huge variety of coloring possibilities for your products.



4





# ELASTOSIL® AND SILPURAN® FOR MEDICAL TECHNOLOGY

## Medically Relevant Properties

Our product portfolio offers a compelling property profile to meet medical-technology needs:

- Available in a broad range of hardnesses (Shore A)
- Excellent heat resistance as well as chemical and physical resistance without any stabilizers
- Highly transparent and easily pigmentable in a broad range of color shades
- Good resistance to UV radiation and X-rays
- Certified biocompatibility (USP<88> class VI and selected tests of ISO 10993)
- Easy to sterilize according to various methods





## Resistance in Standard Sterilization Procedures

All potential hazards must be ruled out for medical products, which is why manufacturers implement various sterilization procedures based on heat (dry heat/steam), chemical substances (ethylene oxide) or radiation ( $\gamma$ ,  $\beta$  radiation). Single-use articles are usually sterilized in their packaging using  $\gamma$ / $\beta$  radiation, or ethylene oxide. Medical products intended for repeated use in settings such as hospitals are usually steam-sterilized.

Ideally, product properties should not be influenced by these procedures.

Mechanical properties are not influenced by ethylene-oxide sterilization in our tests, see Fig. 1. Very slight changes in mechanical properties occur during steam sterilization at 134 °C and up to 500 cycles (Fig. 2).

The use of ionizing radiation may result in changes to the polymer network.

Series of tests have shown that sterilization procedures using  $\gamma$ / $\beta$  radiation make soft materials (5 to 50 shore A) moderately more brittle and influence other mechanical properties as well. Only minor changes occur with harder materials (Fig. 3). However, deterioration of mechanical properties is not critical for most applications: application specifications are usually not compromised and the functionality of the end product remains intact.

## Durability of SILPURAN® When Subjected to Various Sterilization Procedures

**Fig. 1: Sterilization of SILPURAN® 6000/60 using ethylene oxide (ETO)\***

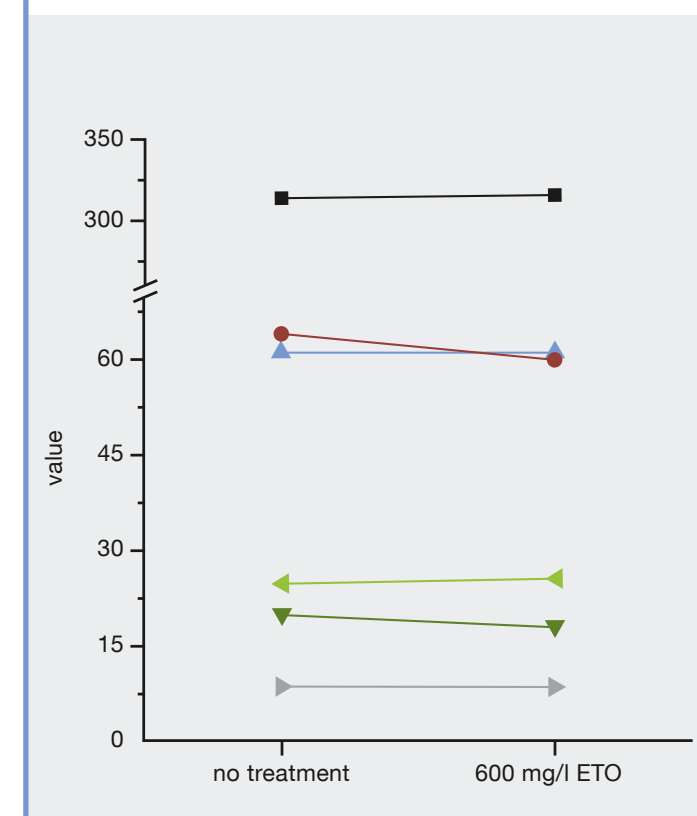

\* according to DIN EN ISO 11135: 1h, 54 °C, 600 mg/L ETO

**Fig. 2: Sterilization of SILPURAN® 6000/60 using steam\*\***

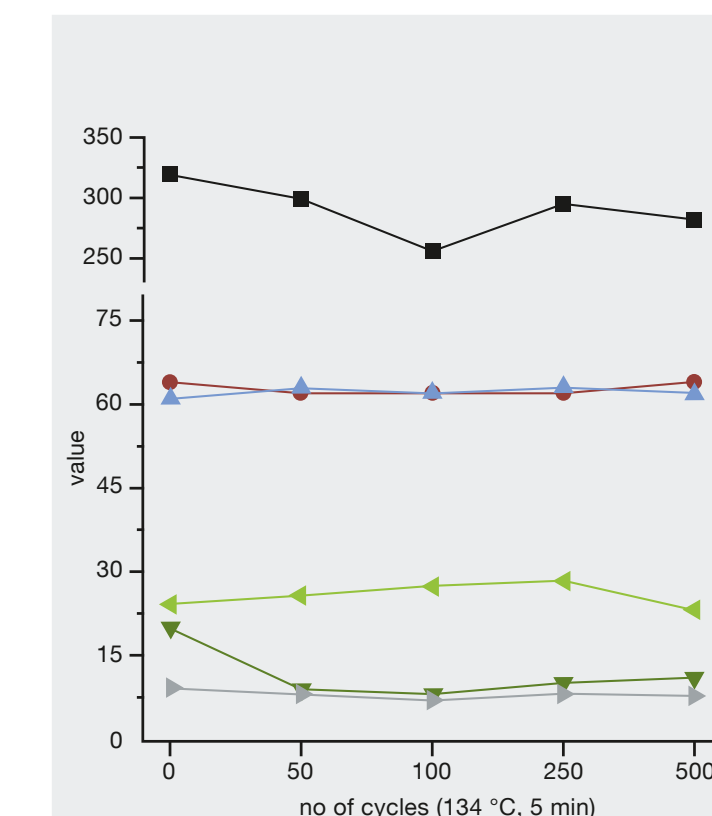

\*\* according to DIN EN ISO 17665 – aging test specified in DIN EN 868-8

**Fig. 3: Sterilization of SILPURAN® 6000/60 using  $\gamma$  radiation\*\*\***

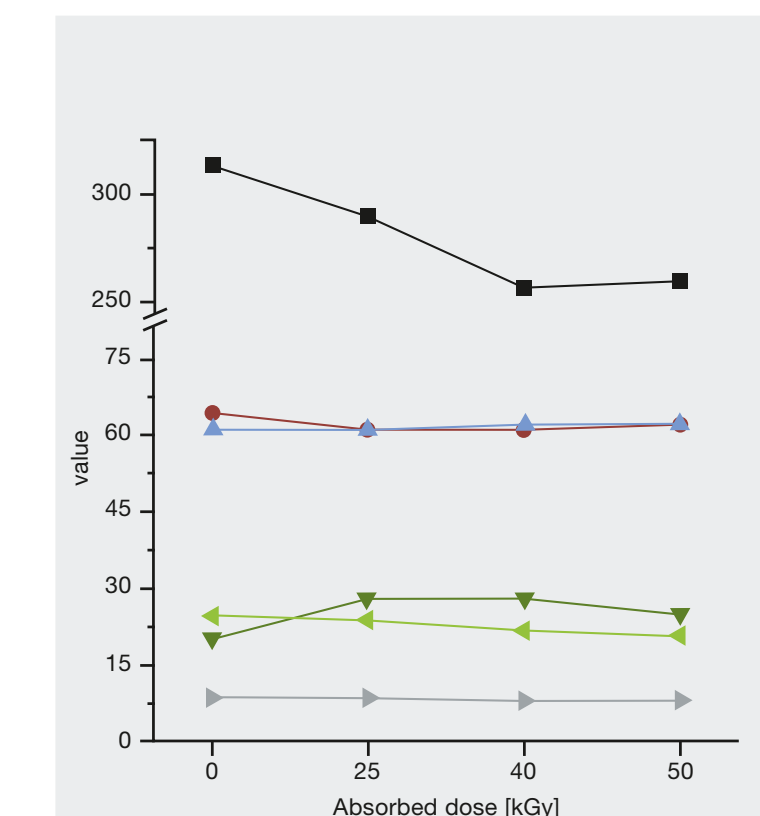

\*\*\* according to DIN EN ISO 11137-2, 2007

- Elongation at break [%]; DIN 53504 S1
- Rebound resilience [%]; DIN 53512
- ▲ Hardness Shore A; DIN 53505
- ▼ Compression set [%] (22 h/175 °C); DIN ISO 815 B
- ◀ Tear strength [N/mm]; ASTM D 624 B
- ▶ Tensile strength [N/mm<sup>2</sup>]; DIN 53504-S1



# ELASTOSIL® AND SILPURAN® FOR A VARIETY OF APPLICATIONS



Duckbill valves

Tube extrusion

Highly transparent molded parts

Silicone elastomers from WACKER are ideal for use in the complex and highly sensitive field of medical technology.

Solid silicone rubber grades are used in numerous tubes in the pharmaceutical and medical industries, such as drainage, breathing and feeding tubes, urinary catheters and tubes for fluid transfer or peristaltic pumps.

Suitable liquid and solid silicone rubber products are injection or compression molded to produce seals, valves, septa, filters and membranes.

Other applications include respirators, respiratory bellows, instrument handles and mats for sterilization trays.





# ADD COLOR TO YOUR MEDICAL TECHNOLOGY PRODUCTS

WACKER is a “one-stop supplier”. We can supply you with suitable color pastes for both solid silicone rubber grades (ELASTOSIL® COLOR PASTES PT) and liquid silicone rubber grades (ELASTOSIL® COLOR PASTES FL).

ELASTOSIL® COLOR PASTES are ready-to-use masterbatches comprising specific pigments and reactive silicone polymers which are commonly used to produce ELASTOSIL® silicone rubber. This ensures a homogeneous covulcanization of the color paste without significant impairment of the physical properties (e.g. hardness) and without migration as it may be observed for systems based on silicone oil. In addition, our ELASTOSIL® COLOR PASTES FL are based on the same low volatile polymers as our ELASTOSIL® LR grades produced in Burghausen. This ensures, that the finished rubber goods have a low volatile content with good results in



migration testing (e.g. Tenax® testing) – in many cases even without post-cure.

Selected tests according to ISO 10993 and USP Class VI were used for verifying biocompatibility of a large number of base colors in order to offer a broad portfolio of color pastes for the medical technology market. You can cover a

huge variety of color shades by using or blending these color pastes.

















#### Note

Should you require a particular color shade not covered by our portfolio or a version having broader approvals (e.g. with respect to food contact or biocompatibility), we are happy to check whether a special formulation is possible. The availability of our color pastes in regions may differ. Please contact our sales colleagues.



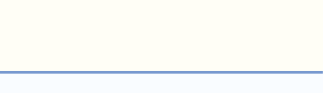
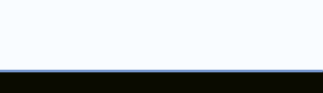

# ADD COLOR TO YOUR MEDICAL TECHNOLOGY PRODUCTS













ELASTOSIL® COLOR PASTES PT – Standard Colors							
Product Color	Similar to <sup>(1)</sup>	Suffix	BfR <sup>(2)</sup>	FDA <sup>(3)</sup>	ISO 10993 <sup>(4)</sup>	USP Class VI <sup>(4)</sup>	Color
EL PT Yellow	RAL 1016		●	B-H	●	●	
EL PT Yellow	RAL 1026	F	●	C-H	●	●	
EL PT Orange	RAL 2004	F	●	B-H	●	●	
EL PT Red	RAL 3000	F	●	C-H	●	●	
EL PT Red Brown	RAL 3013		●	A-H	●	●	
EL PT Traffic Red	RAL 3020		●	B-H	●	●	
EL PT Red Violet	RAL 4002		●	A-H	●	●	
EL PT Ultramarine Blue	RAL 5002		●	A-H	●	●	
EL PT Dark Blue	RAL 5010		●	A-H	●	●	
EL PT Blue	RAL 5022		●	A-H	●	●	
EL PT Heliogreen	RAL 6004		●	A-H	●	●	
EL PT Green	RAL 6017		●	A-H	●	●	
EL PT Gray	RAL 7040		●	A-H	●	●	
EL PT Deep Black	RAL 9005 <sup>5</sup>		●	A-H	●	●	
EL PT White	RAL 9010		●	A-H	●	●	
EL PT Traffic White	RAL 9016		●	A-H	●	●	
EL PT Black	RAL 9011	F	●	A-H	●	●	
EL PT Laser Marking White	-		●	A-H	○		
EL PT Laser Marking Black	-		●	E-G	○		

- (1) The RAL values are intended as a guide.
- (2) Complies with the requirements of BfR recommendations “XV. Silicones“ and „IX. Colorants for Plastics and other Polymers Used in Commodities“ (For details see the actual issue of our Product Compliance Sheet or the separate Food Contact Statement of the respective ELASTOSIL® COLOR PASTE.)
- (3) Complies with the requirements of FDA regulation CFR 21§177.2600 „Rubber Articles Intended for Repeated Use“. Use condition see table 2 in 21 CFR§176.170 (c). Further limits, e.g. with respect to maximum allowed dosage may occur. (For details see the actual issue of our Product Compliance Sheet or the separate Food Contact Statement of the respective ELASTOSIL® COLOR PASTE).
- (4) USP<88> class VI and selected tests according to ISO 10993 or statement by analogy available. For statements regarding the biocompatibility of our ELASTOSIL® COLOR PASTES FL and PT, please contact our technical service department.
- (5) Not suitable for use with curing agent E and E2.  
○ only ISO 10993-5 (Cytotoxicity)



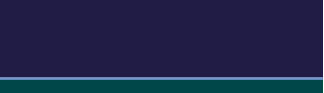
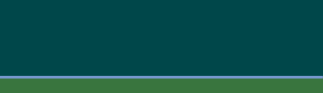

# ADD COLOR TO YOUR MEDICAL TECHNOLOGY PRODUCTS

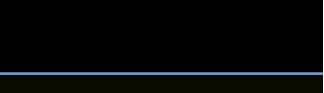
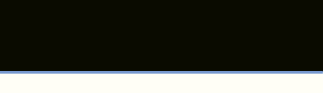
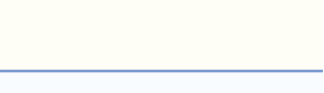
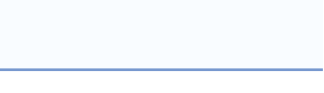
ELASTOSIL® COLOR PASTES FL – Standard Colors							
Product Color	Similar to <sup>(1)</sup>	Suffix	BfR <sup>(2)</sup>	FDA <sup>(3)</sup>	ISO 10993 <sup>(4)</sup>	USP Class VI <sup>(4)</sup>	Color
EL FL Yellow	RAL 1016		●	A-H	●	●	
EL FL Yellow	RAL 1026	F	●	C-H	●	●	
EL FL Orange	RAL 2004	F	●	B-H	●	●	
EL FL Red	RAL 3000	F	●	C-H	●	●	
EL FL Red Iron Oxide	RAL 3013		●	A-H	●	●	
EL FL Red	RAL 3020		●	B-H	●	●	
EL FL Red Violet	RAL 4002		●	A-H	●	●	
EL FL Ultramarine Blue	RAL 5002		●	A-H	●	●	
EL FL Dark Blue	RAL 5010		●	A-H	●	●	
EL FL Light Blue	RAL 5015	F	●	A-H	●	●	
EL FL Blue	RAL 5022		●	A-H	●	●	
EL FL Heliogreen	RAL 6004		●	A-H	●	●	
EL FL Green	RAL 6010		●	A-H	●	●	
EL FL Black	RAL 9005	F	●	A-H	●	●	
EL FL Deep Black	RAL 9011		●	A-H	●	●	
EL FL White	RAL 9010		●	A-H	●	●	
EL FL Traffic White	RAL 9016		●	A-H	●	●	
EL FL Laser Marking White	-		●	A-H	○		
EL FL Laser Marking Black	-		●	E-G	○		

- (1) The RAL values are intended as a guide.
  - (2) Complies with the requirements of BfR recommendations “XV. Silicones“ and „IX. Colorants for Plastics and other Polymers Used in Commodities“ (For details see the actual issue of our Product Compliance Sheet or the separate Food Contact Statement of the respective ELASTOSIL® COLOR PASTE.)
  - (3) Complies with the requirements of FDA regulation CFR 21§177.2600 „Rubber Articles Intended for Repeated Use“. Use condition see table 2 in 21 CFR§176.170 (c). Further limits, e.g. with respect to maximum allowed dosage may occur. (For details see the actual issue of our Product Compliance Sheet or the separate Food Contact Statement of the respective ELASTOSIL® COLOR PASTE).
  - (4) USP<88> class VI and selected tests according to ISO 10993 or statement by analogy available. For statements regarding the biocompatibility of our ELASTOSIL® COLOR PASTES FL and PT, please contact our technical service department.
  - (5) Not suitable for use with curing agent E and E2.
- only ISO 10993-5 (Cytotoxicity)





# MANUFACTURING PROCESSES FOR SOLID SILICONE RUBBER (HCR)

HCR can be processed using various methods, such as extrusion, coextrusion, compression molding, transfer molding or injection molding.

Schematic diagram of an extruder with crosshead die

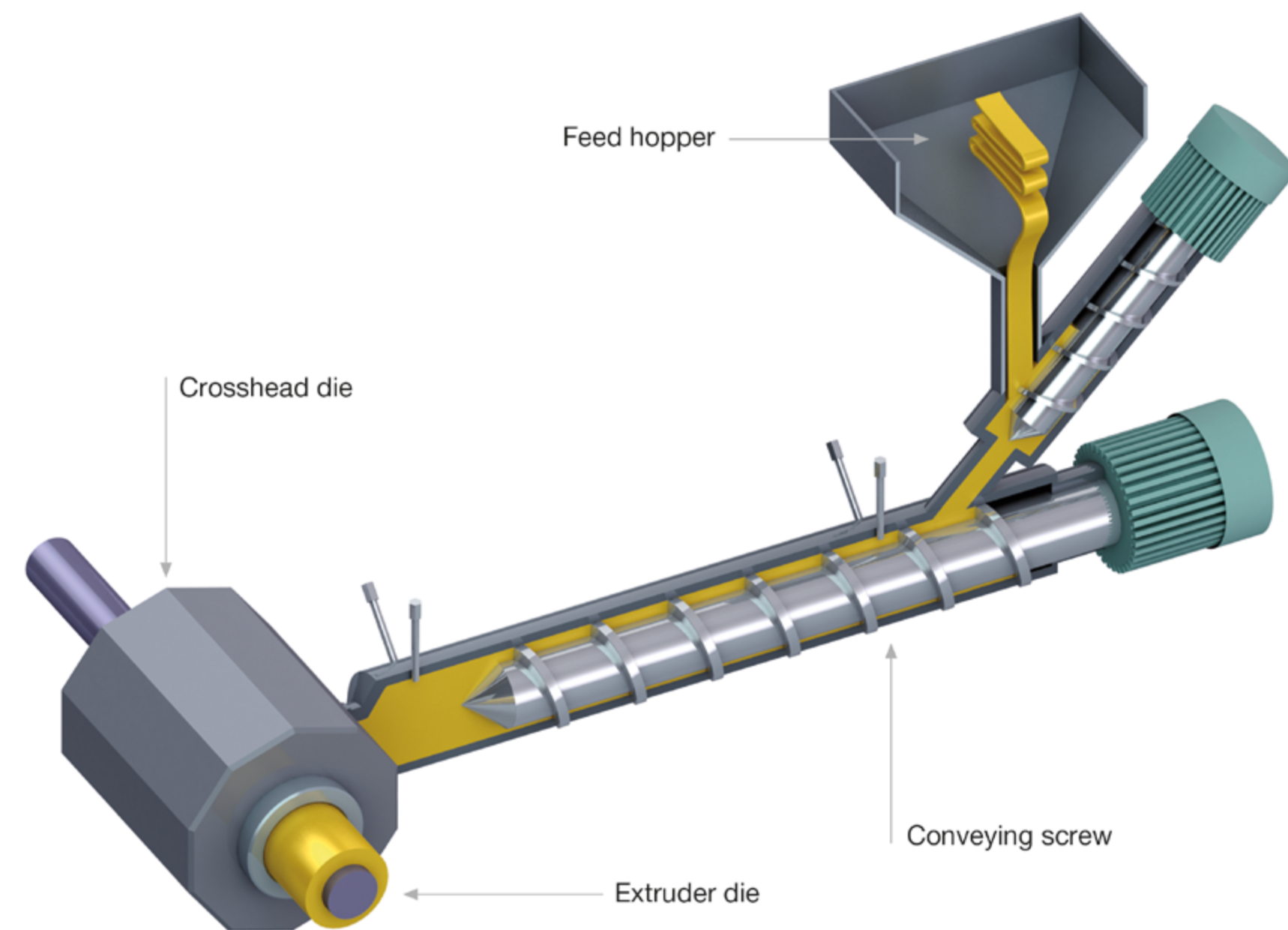

## Extrusion

Extrusion is a continuous manufacturing process in which silicone rubber is forced through a die and then vulcanized. The die is responsible for giving the extruded material its shape. The necessary pressure is produced via a conveying screw, in which the material is homogenized, compacted and degassed. One example of products made this way is tubing for the medical and pharmaceutical industries.





# MANUFACTURING PROCESSES FOR LIQUID SILICONE RUBBER (LSR)

LSR can be processed by injection molding. Nowadays, this processing technology becomes more and more popular for HCR as well.

Schematic diagram of LSR injection molding with metering unit and mixing station

## Injection Molding

Injection molding is currently the most popular and efficient method for processing large quantities of silicones meeting strict demands for consistently high product quality. Liquid silicone rubber can be used in the production of seals, membranes and valves – the process is fully automatic.

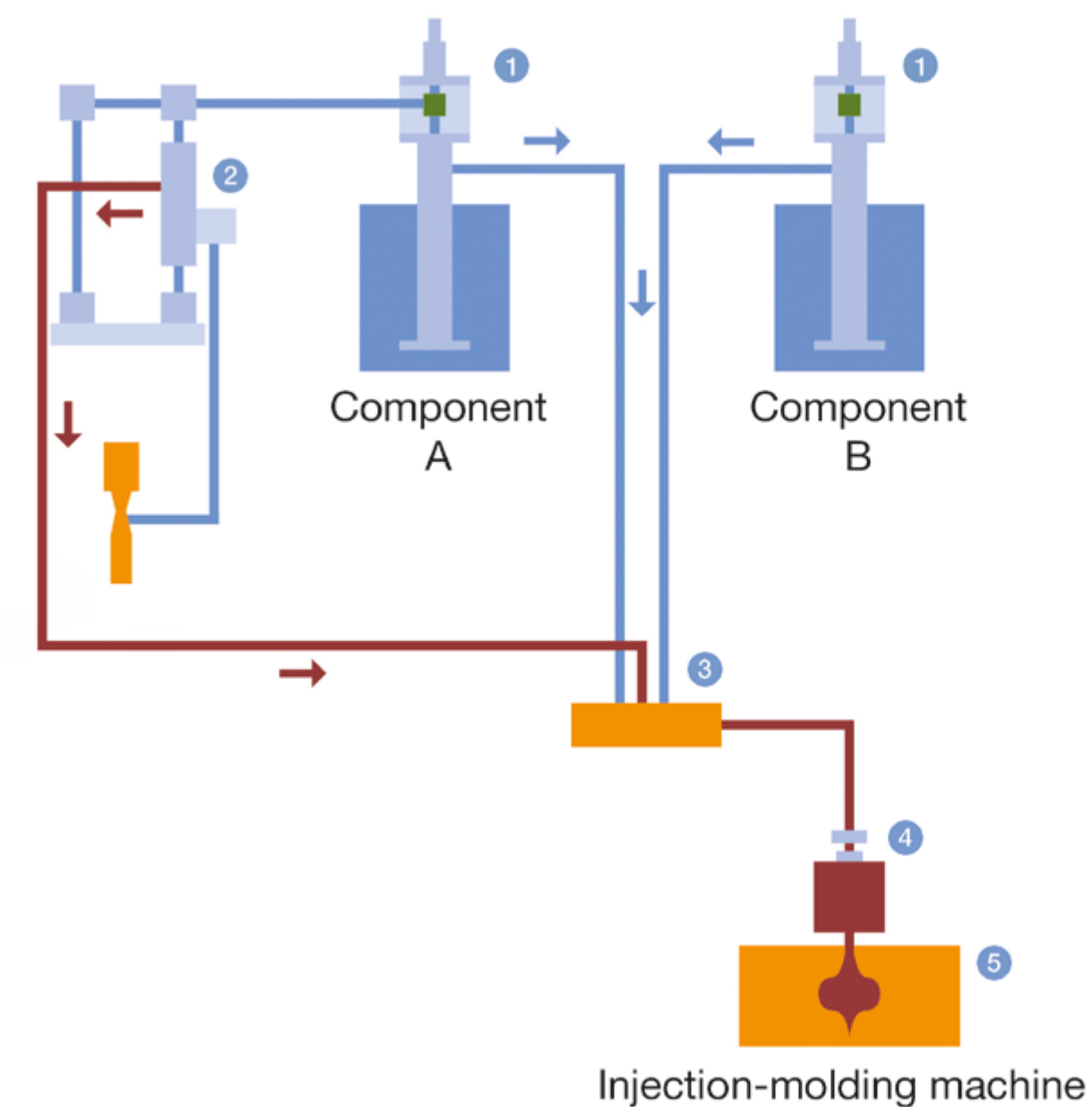

- 1 Metering unit for the A and B components of the liquid silicone rubber
- 2 Metering unit for color / additives
- 3 Mixing station
- 4 Metering cylinder
- 5 Heated injection mold with injection-molded part

## More information

[www.wacker.com/silpuran](http://www.wacker.com/silpuran)

[www.wacker.com/elastosil](http://www.wacker.com/elastosil)



12





# A SAFE BET FOR FUTURE SUCCESS

## Progress Rooted in Tradition

As early as 1947, WACKER became the first European company to venture into research in the field of silicones. This was the beginning of a success story that established WACKER as a European pioneer in silicone chemistry, and made it into one of the world's leading silicone manufacturers.

## Future-Proof Quality Right From the Start

WACKER's internal raw materials network ensures the future availability of raw materials, guaranteeing the finest quality and maximizing traceability back to the original source. This provides the ideal basis for further processing in accordance with stringent quality criteria.

## Investing in Pioneering Solutions

Investment in research and development far exceeding the global

chemical-industry average paves the way for cutting-edge innovations, ensuring that ELASTOSIL® and SILPURAN® always fulfill the ever-increasing industry demands.

## Keeping Ahead of Challenges with Confidence

SILPURAN® as well as many grades of the ELASTOSIL® family are tested for biocompatibility and comply with current standards for modern medical technology. (See info box on the right: "Certified Safe")

## Safety Features for the Challenges of the Future

In addition to their extraordinary purity, compelling properties of ELASTOSIL® and SILPURAN® also include excellent tolerability and utter reliability. These silicones are steam-sterilizable, resistant to heat and radiation, highly flexible and available across a very broad range of

Shore hardness values. Moreover, silicones do not contain any phthalates, other organic plasticizers, latex, plant proteins, organic stabilizers or animal-based materials.

## Reliable Application Characteristics

- Biocompatibility
- Biodurability: low surface tension, thermal stability, chemical stability, excellent mechanical properties
- Good resistance to a large number of solvents and chemicals
- Sterilizable for single and repeated use (sterilizable with steam, ethylene oxide, electron beams and  $\gamma$ -rays)
- Good weathering, UV and aging resistance
- Highly transparent
- Silicones do not support microbial growth

## Certified Safe

- The SILPURAN® product line as well as many grades of the ELASTOSIL® family have been tested for biocompatibility according to USP class VI and selected tests according to ISO 10993
- Many ELASTOSIL® and SILPURAN® LSR/HTV grades comply with the requirements of the BfR (German Institute for Risk Assessment, XV Silicones, Section III, Silicone Elastomers) and the FDA CFR 21 §. 177.2600 "Rubber articles intended for repeated use", making them suitable for food contact





# SILPURAN® HIGH PURITY TO MEET THE HEALTHCARE NEEDS



[More information](#)

[www.wacker.com/healthcare](http://www.wacker.com/healthcare)

WACKER's SILPURAN® product line was developed to meet the needs of the healthcare industry<sup>1</sup>.

SILPURAN® products contain defined ingredients only and do not contain organic plasticizers.

SILPURAN® products provide biocompatibility based on certified compliance according to selected ISO 10993 and USP Class VI tests.

All products are produced according to the WACKER CLEAN OPERATIONS standard to meet the highest quality and cleanliness needs of healthcare applications.

## Key features of WACKER CLEAN OPERATIONS

- Selected mixers, 50 µm filtration
- Air-controlled filling environment
- Trained, qualified employees
- Documentation and tracking

The WACKER CLEAN OPERATIONS standard has been implemented at several WACKER production sites.

<sup>1</sup> Limited to the WACKER SILICONES healthcare policy





# SILPURAN® – LIQUID SILICONE RUBBER

Produced in accordance with the WACKER CLEAN OPERATIONS Standard

Product	Properties	Typical Applications	Hardness Shore A	Tensile Strength (DIN 53 504-S1) [N/mm <sup>2</sup> ]	Elongation at Break (DIN 53 504-S1) [%]	Tear Resistance (ASTM D 624 B) [N/mm]	USP Class VI <sup>(1)</sup>	ISO 10993 <sup>(2)</sup>	BfR <sup>(3)</sup>	FDA <sup>(4)</sup>
SILPURAN® 6000	Multi purpose	Seals, connectors, valves, bellows, etc.	05	2.5	700	6	●	●	●	
			10	4.2	740	12	●	●	●	
			20	8.0	850	21	●	●	●	●
			30	8.6	650	25	●	●	●	●
			40	9.6	600	29	●	●	●	●
			50	10.0	480	30	●	●	●	●
			60	10.0	350	27	●	●	●	●
			70	9.5	290	22	●	●	●	●
SILPURAN® 6600	Low coefficient of friction, reduced self healing	Easy to assemble parts. Seals, valves, etc.	40	9.4	550	35	●	●	●	●
			50	8.9	440	31	●	●	●	●
			60	9.0	310	26	●	●	●	●

These figures are only intended as a guide and should not be used in preparing specifications. Please contact us regarding our products' conformity to the European Pharmacopoeia, section 3.1.9 "Silicone elastomers for closures and tubing" Please contact your technical service manager to see whether ELASTOSIL® products are suitable for your projects and applications.

(1) Systemic / intracutaneous toxicity, implantation test (5 days)

(2) Cytotoxicity, sensitization LLNA, pyrogenicity, additional tests upon request

(3) BfR recommendation "XV. Silicone" (BfR = Bundesinstitut für Risikobewertung) (German Institute for Risk Assessment)

(4) FDA 21 CFR § 177.2600 "Rubber articles intended for repeated use" (FDA = Food and Drug Administration)





# SILPURAN® – LIQUID SILICONE RUBBER

Produced in accordance with the WACKER CLEAN OPERATIONS Standard

Product	Properties	Typical Applications	Hardness Shore A	Tensile Strength (DIN 53 504-S1) [N/mm <sup>2</sup> ]	Elongation at Break (DIN 53 504-S1) [%]	Tear Resistance (ASTM D 624 B) [N/mm]	USP Class VI <sup>(1)</sup>	ISO 10993 <sup>(2)</sup>	BfR <sup>(3)</sup>	FDA <sup>(4)</sup>
SILPURAN® 6610	Reduced healing, esp. during radiation treatment	Needle-free valves, slotted membranes	40	7.2	550	32	●	●	●	●
			50	8.0	440	31	●	●	●	●
			60	7.0	310	26	●	●	●	●
SILPURAN® 6700	Self-adhesive on many substrates	2 component injection molded parts	40	8.5	640	23	●	●	●	●
			50	8.5	590	24	●	●	●	●
			60	8.2	490	26	●	●	●	●
SILPURAN® 6740	Self-adhesive on many substrates, high tear resistance	2 component injection molded parts	40	9.2	710	25	●	●	●	●
SILPURAN® 6760	Self-adhesive on many substrates, low coefficient of friction	2 component injection molded parts	50	8.4	600	27	●	●	●	●

These figures are only intended as a guide and should not be used in preparing specifications. Please contact us regarding our products' conformity to the European Pharmacopoeia, section 3.1.9 "Silicone elastomers for closures and tubing" Please contact your technical service manager to see whether ELASTOSIL® products are suitable for your projects and applications.

(1) Systemic / intracutaneous toxicity, implantation test (5 days)

(2) Cytotoxicity, sensitization LLNA, pyrogenicity, additional tests upon request

(3) BfR recommendation "XV. Silicone" (BfR = Bundesinstitut für Risikobewertung) (German Institute for Risk Assessment)

(4) FDA 21 CFR § 177.2600 "Rubber articles intended for repeated use" (FDA = Food and Drug Administration)





# ELASTOSIL® – LIQUID SILICONE RUBBER

Product	Properties	Typical Applications	Hardness Shore A	Tensile Strength (DIN 53 504-S1) [N/mm <sup>2</sup> ]	Elongation at Break (DIN 53 504-S1) [%]	Tear Resistance (ASTM D 624 B) [N/mm]	USP Class VI <sup>(1)</sup>	ISO 10993 <sup>(2)</sup>	BfR <sup>(3)</sup>	FDA <sup>(4)</sup>
ELASTOSIL® LR 34004	X-ray opaque	X-ray opaque injection molded parts	50	7.8	450	26	●	●	●	●
ELASTOSIL® LR 5040	Low volatiles content, without post-curing, high tear resistance	Cost-effective, large-scale production of injection-molded parts, like menstrual cups, seals, gaskets	20	7.9	890	33	●	●	●	●
			30	9.2	760	32	●	●	●	●
			40	9.0	580	38	●	●	●	●
			45	9.0	580	38	●	●	●	●
			50	9.5	490	42	●	●	●	●
			60	9.0	380	50	●	●	●	●
			70	9.5	370	36	●	●	●	●
ELASTOSIL® LR 3078	Self-adhesive to polycarbonate and some high performance plastics like PPE, PSU, PESU, PPSU and PEI	CPAP masks, gaskets and other medical parts	20	5.3	680	12	●	●		
			30	4.9	620	15	○	○		
			40	8.5	590	24	●	●		
			50	8.7	490	23	○	○		
			60	8.2	430	30	○	○		
			70	7.7	350	25	●	●		

Also other ELASTOSIL® LSR grades are suitable for medical applications. Please contact your Sales Manager for further details.

These figures are only intended as a guide and should not be used in preparing specifications. Please contact us regarding our products' conformity to the European Pharmacopoeia, section 3.1.9 "Silicone elastomers for closures and tubing" Please contact your technical service manager to see whether ELASTOSIL® products are suitable for your projects and applications.

(1) Systemic / intracutaneous toxicity, implantation test (5 days)

(2) Cytotoxicity, sensitization LLNA, pyrogenicity, additional tests upon request

(3) BfR recommendation "XV. Silicone" (BfR = Bundesinstitut für Risikobewertung) (German Institute for Risk Assessment)

(4) FDA 21 CFR § 177.2600 "Rubber articles intended for repeated use" (FDA = Food and Drug Administration)

○ Biocompatibility statement by analogy available





# ELASTOSIL® – SOLID SILICONE RUBBER (ADDITION CURED)

Product	Properties	Typical Applications	Hardness Shore A	Tensile Strength (DIN 53 504-S1) [N/mm <sup>2</sup> ]	Elongation at Break (DIN 53 504-S1) [%]	Tear Resistance (ASTM D 624 B) [N/mm]	USP Class VI <sup>(1)</sup>	ISO 10993 <sup>(2)</sup>	BfR <sup>(3)</sup>	FDA <sup>(4)</sup>
ELASTOSIL® R plus 4001	1K HCR for molding	Molded parts	20	8	1300	34	●	●	●	●
			30	11.5	1090	43	●	●	●	●
			40	11.8	930	38	●	●	●	●
			50	11.5	830	35	●	●	●	●
			60	11	710	30	●	●	●	●
			70	10.3	660	38	●	●	●	●
			80	8	570	29	●	●	●	●
ELASTOSIL® R plus 4305	2K HCR for extrusion	Extruded parts	30	11.8	1100	43	●	●	●	●
			40	9.8	830	27	○	○	●	●
			50	8.8	770	35	●	●	●	●
			60 S	9.9	630	38	●	●	●	●
			70	9.1	600	39	●	●	●	●
			80	7.8	310	21	●	●	●	●
			90	6.4	150	17	●	●	●	●

These figures are only intended as a guide and should not be used in preparing specifications. Please contact us regarding our products' conformity to the European Pharmacopoeia, section 3.1.9 "Silicone elastomers for closures and tubing" Please contact your technical service manager to see whether ELASTOSIL® products are suitable for your projects and applications.

(1) Systemic / intracutaneous toxicity, implantation test (5 days)

(2) Cytotoxicity, sensitization LLNA, pyrogenicity, additional tests upon request

(3) BfR recommendation "XV. Silicone" (BfR = Bundesinstitut für Risikobewertung) (German Institute for Risk Assessment)

(4) FDA 21 CFR § 177.2600 "Rubber articles intended for repeated use" (FDA = Food and Drug Administration)

○ Biocompatibility statement by analogy available





# ELASTOSIL® AND SILPURAN® – SOLID SILICONE RUBBER (ADDITION CURED)

Product	Properties	Typical Applications	Hardness Shore A	Tensile Strength (DIN 53 504-S1) [N/mm <sup>2</sup> ]	Elongation at Break (DIN 53 504-S1) [%]	Tear Resistance (ASTM D 624 B) [N/mm]	USP Class VI <sup>(1)</sup>	ISO 10993 <sup>(2)</sup>	BfR <sup>(3)</sup>	FDA <sup>(4)</sup>
ELASTOSIL® R plus 4360	High rebound resilience and low compression set	Extruded parts, e.g. peristaltic pump hoses	60	8.4	380	18	●	●	●	●
ELASTOSIL® R plus 4366	Low coefficient of friction	Extruded parts, e.g. peristaltic pump hoses	60	7.6	620	42	○	○	●	●
SILPURAN® AUX 8251 RO	Barium sulfate batch (71 %) for addition-curing silicone rubber compounds	X-ray opaque addition cured parts					●	●	●	●

These figures are only intended as a guide and should not be used in preparing specifications. Please contact us regarding our products' conformity to the European Pharmacopoeia, section 3.1.9 "Silicone elastomers for closures and tubing" Please contact your technical service manager to see whether ELASTOSIL® products are suitable for your projects and applications.

(1) Systemic / intracutaneous toxicity, implantation test (5 days)

(2) Cytotoxicity, sensitization LLNA, pyrogenicity, additional tests upon request

(3) BfR recommendation "XV. Silicone" (BfR = Bundesinstitut für Risikobewertung) (German Institute for Risk Assessment)

(4) FDA 21 CFR § 177.2600 "Rubber articles intended for repeated use" (FDA = Food and Drug Administration)

○ Biocompatibility statement by analogy available





# ELASTOSIL® AND SILPURAN® – SOLID SILICONE RUBBER (PEROXIDE CURED)

Product	Properties	Typical Applications	Hardness Shore A	Tensile Strength (DIN 53 504-S1) [N/mm <sup>2</sup> ]	Elongation at Break (DIN 53 504-S1) [%]	Tear Resistance (ASTM D 624 B) [N/mm]	USP Class VI <sup>(1)</sup>	ISO 10993 <sup>(2)</sup>	BfR <sup>(3)</sup>	FDA <sup>(4)</sup>
ELASTOSIL® R 401	General purpose HCR, peroxide cure	Molded and extruded parts	30 S	10	910	28	●	●	●	●
			40 S	10	580	23	●	●	●	●
			50 S	11	520	23	●	○	●	●
			60 S	11	440	24	●	○	●	●
			70 S	11	440	26	●	○	●	●
			80 S	10	440	28	●	●	●	●
			90 S	7.9	270	22	●	○	●	●
SILPURAN® AUX 8250 RO	Barium sulfate batch (75 %) for peroxide- curing silicone rubber compounds	X-ray opaque peroxide cured parts					●	●	●	●

These figures are only intended as a guide and should not be used in preparing specifications. Please contact us regarding our products' conformity to the European Pharmacopoeia, section 3.1.9 "Silicone elastomers for closures and tubing" Please contact your technical service manager to see whether ELASTOSIL® products are suitable for your projects and applications.

(1) Systemic / intracutaneous toxicity, implantation test (5 days)  
 (2) Cytotoxicity, sensitization LLNA, pyrogenicity, additional tests upon request  
 (3) BfR recommendation "XV. Silicone" (BfR = Bundesinstitut für Risikobewertung) (German Institute for Risk Assessment)  
 (4) FDA 21 CFR § 177.2600 "Rubber articles intended for repeated use" (FDA = Food and Drug Administration)  
 ○ Biocompatibility statement by analogy available





# PERFECT SERVICE – GLOBALLY CONNECTED, LOCALLY AVAILABLE

### Innovation Through Dialog

Individual services play a decisive role in the healthcare industry. Hardly any other field is as dynamic or innovative. Your market success is determined by the support of a competent and experienced partner who assists you through each phase of product development.

You can tap into the full potential of WACKER's silicone rubber compounds by consulting us on anything from materials development, to tests, pilot series and registration – all in accordance with the latest regulations. All around the world, we support you with our highly experienced specialists, state-of-the-art research labs and application expertise. ELASTOSIL® and SILPURAN® are top-quality, extraordinarily flexible products. A broad range of these products can be customized to meet your individual requirements.

Speak with a WACKER sales manager about how you plan to use ELASTOSIL® and SILPURAN®. These individuals are well acquainted with standard production processes. They also have a profound technical understanding of your requirements, and know how best to incorporate these requirements into the properties of our silicone elastomers. Innovative and custom solutions thrive on dialog between experts.

### Applications Labs

Our technical service engineers will work closely with you and tackle specific questions from actual practice. Worldwide, we offer assistance by finding the optimum product for your specific requirements and by supporting your product development from material selection through to industrial production. Because the labs' primary focus is on medical technology, they possess outstanding expertise in this field.

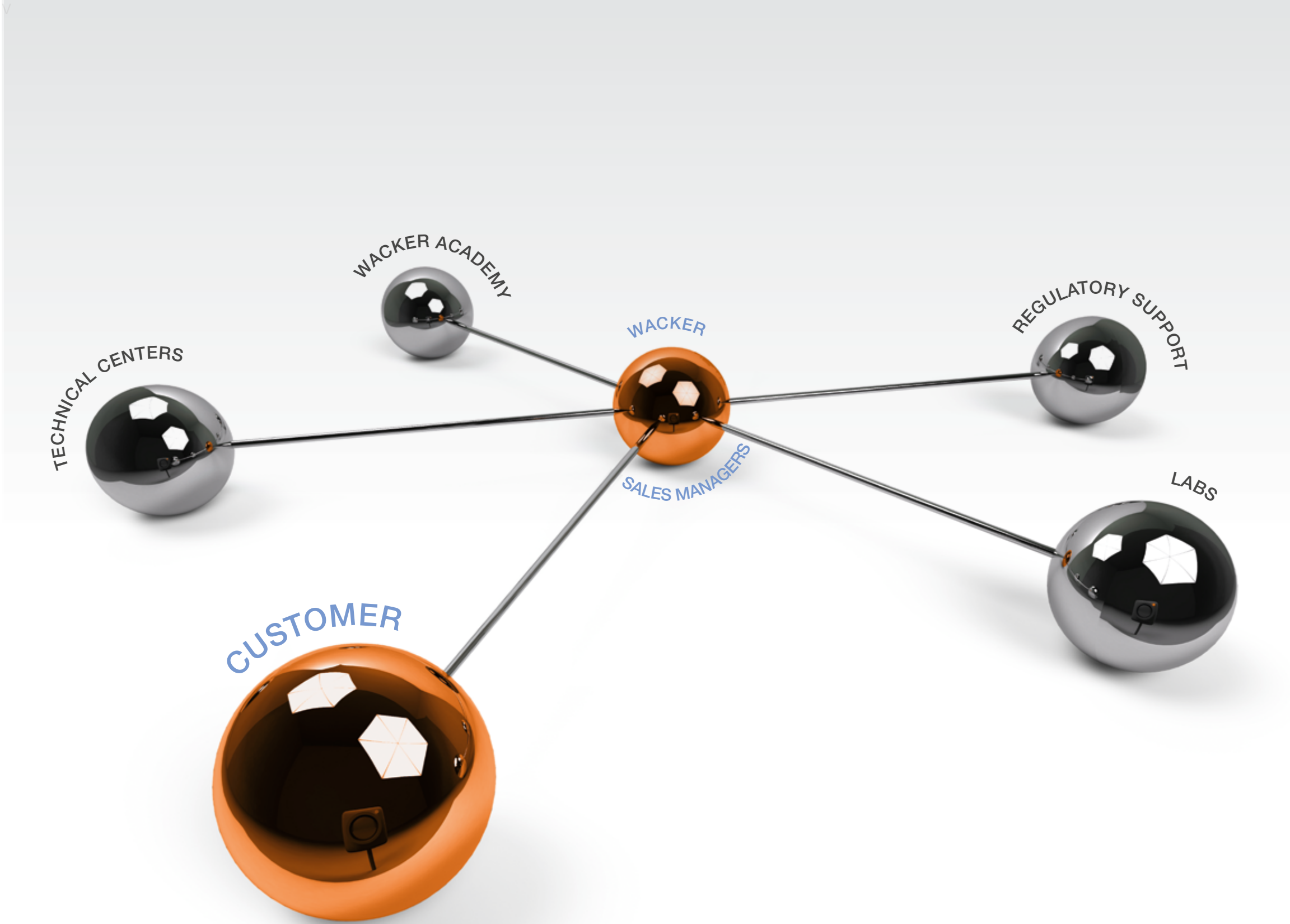



## Technical Centers

We maintain technical centers in all key regions to proactively assist you in any technical matters, from adjusting formulations, to meeting individual requirements, to testing the properties of rubber compounds and cured material. Our technical centers are equipped to perform all relevant analyses, lab tests and trials for you according to international and local standards and regulations.

Besides our local experts, you can also draw on our international knowledge network based on over 50 years of market experience. For example, our pilot plant in Burghausen forms the interface between product and applications expertise. It is equipped with a lab and test facilities, as well as production systems (extrusion and injection molding) for HTV and LSR silicone rubber, and 2-component composite materials.

At our pilot plant, we put our product lines through a range of practical tests as part of their development, testing, modification and optimization. At the same time, we offer extensive advice at every step in the supply chain, and put our pilot plant and all the necessary tools at your disposal. We can also offer on-site consultation at your production plant.

## The WACKER ACADEMY

To transfer its own expertise and market experience, WACKER has founded a unique institution, the WACKER ACADEMY. Here, at a number of sites worldwide, you can take advantage of a versatile, industry-specific seminar program. To access the current program, please go to: [www.wacker.com/wacker-academy](http://www.wacker.com/wacker-academy)

## More information

[www.wacker.com/customer-service](http://www.wacker.com/customer-service)

## Regulatory Support

To ensure product safety, we of course offer you regulatory support. Our experts will respond to your questions about environmental, health and regulatory matters such as the following:

- Suitability for contact with food products (e.g. BfR, FDA)
- Pharmaceutical and medical applications (e.g. European Pharmacopeia and US Pharmacopeia)
- National and international directives and regulations (e.g. the KTW Guideline, EU-RoHS, REACH)
- Specific customer requirements (e.g. banned substance and substances avoidance lists)
- Toxicology and ecotoxicology
- Risk analysis

## Infoline

- We have set up an information hotline so that you can start talking with us quickly and easily. For all questions concerning WACKER silicones and related products and services, just call us or email us. You will be redirected to a specialist who can answer your questions.
- **Europe and the Middle East**
- Infoline Germany  
**0800-6279-800**
- Infoline International  
**+49 89 6279-1741**
- Email: [info.silicones@wacker.com](mailto:info.silicones@wacker.com)
- **NAFTA Region – Canada, Mexico and the USA**
- Infoline **+1 888-922-5374**  
**(+1 888-WACKER 4 U)**
- Email: [info.usa@wacker.com](mailto:info.usa@wacker.com)



# CREATING TOMORROW'S SOLUTIONS

## A Diverse Array of Products For Growing Markets

Our product portfolio ranges from silicones, binders and polymeric additives to bioengineered pharmaceutical actives. In addition, we offer hyperpure silicon for semiconductors and solar applications.

## Innovations That Improve The Quality of Life

As a technology leader focusing on sustainability, WACKER promotes products and ideas that offer considerable value-added potential to ensure that current and future generations enjoy a better quality of life, based on energy efficiency and protection of the climate and environment.

## Global Knowledge For Local Markets

When you work with WACKER, you have 100 years of chemical expertise at your disposal, with access to the research findings and best practices of our experts throughout the world. Our knowledge base consists of a network of 23 technical centers, 14 training centers and our basic research center.

### More information

[www.wacker.com/sustainability](http://www.wacker.com/sustainability)

**And most importantly: we are there. Worldwide. Wherever and whenever you need us.**

**Our local specialists know your markets and speak your language. By working with them, you will find innovative solutions that win over your customers and make you more competitive.**

### Follow us:

Find us on LinkedIn, YouTube and Twitter. We'll keep you up to date on the latest issues.



All figures are based on fiscal 2022.



## Silicones and Polymers

3,200 specialty products from organic and inorganic chemistry



## Global Market Leader

In dispersions and dispersible polymer powders based on vinyl acetate-ethylene (VAE), in building-protection silicones and in the production of cyclodextrin and cystein.



## Globally Active

- Sites worldwide
- Headquartered in Munich
- 27 production sites in Europe, Asian and the Americas
- 26 technical centers
- 14 WACKER ACADEMY training centers
- 52 sales offices



**Employees: 15,700**



## Total Sales

€8.21 billion



23







**WACKER**

**Wacker Chemie AG**

Hanns-Seidel-Platz 4  
81737 Munich, Germany  
[www.wacker.com/contact](http://www.wacker.com/contact)

[www.wacker.com](http://www.wacker.com)

Follow us on:   

ELASTOSIL® is a registered trademark of Wacker Chemie AG.

SILPURAN® is a registered trademark of Wacker Chemie AG.

The data presented in this medium are in accordance with the present state of our knowledge but do not absolve the user from carefully checking all supplies immediately on receipt. We reserve the right to alter product constants within the scope of technical progress or new developments. The recommendations made in this medium should be checked by preliminary trials because of conditions during processing over which we have no control, especially where other companies' raw materials are also being used. The information provided by us does not absolve the user from the obligation of investigating the possibility of infringement of third parties' rights and, if necessary, clarifying the position. Recommendations for use do not constitute a warranty, either express or implied, of the fitness or suitability of the product for a particular purpose.