



**WACKER**

CREATING TOMORROW'S SOLUTIONS

## **Managing for Growth and Cash**

Tobias Ohler, CFO, Wacker Chemie AG

# Disclaimer

The information contained in this presentation is for background purposes only and is subject to amendment, revision and updating. Certain statements and information contained in this presentation may relate to future expectations and other forward-looking statements that are based on management's current views and assumptions and involve known and unknown risks and uncertainties. In addition to statements which are forward-looking by reason of context, including without limitation, statements referring to risk limitations, operational profitability, financial strength, performance targets, profitable growth opportunities, and risk adequate pricing, other words such as "may, will, should, expects, plans, intends, anticipates, believes, estimates, predicts, or continue", "potential, future, or further", and similar expressions identify forward-looking statements. By their nature, forward-looking statements involve a number of risks, uncertainties and assumptions which could cause actual results or events to differ materially from those expressed or implied by the forward-looking statements. These include, among other factors, changing business or other market conditions and the prospects for growth anticipated by the Company's management. These and other factors could adversely affect the outcome and financial effects of the plans and events described herein. Statements contained in this presentation regarding past trends or activities should not be taken as a representation that such trends or activities will continue in the future. The Company does not undertake any obligation to update or revise any statements contained in this presentation, whether as a result of new information, future events or otherwise. In particular, you should not place undue reliance on forward-looking statements, which speak only as of the date of this presentation.

# WACKER: Well Positioned for Future Growth

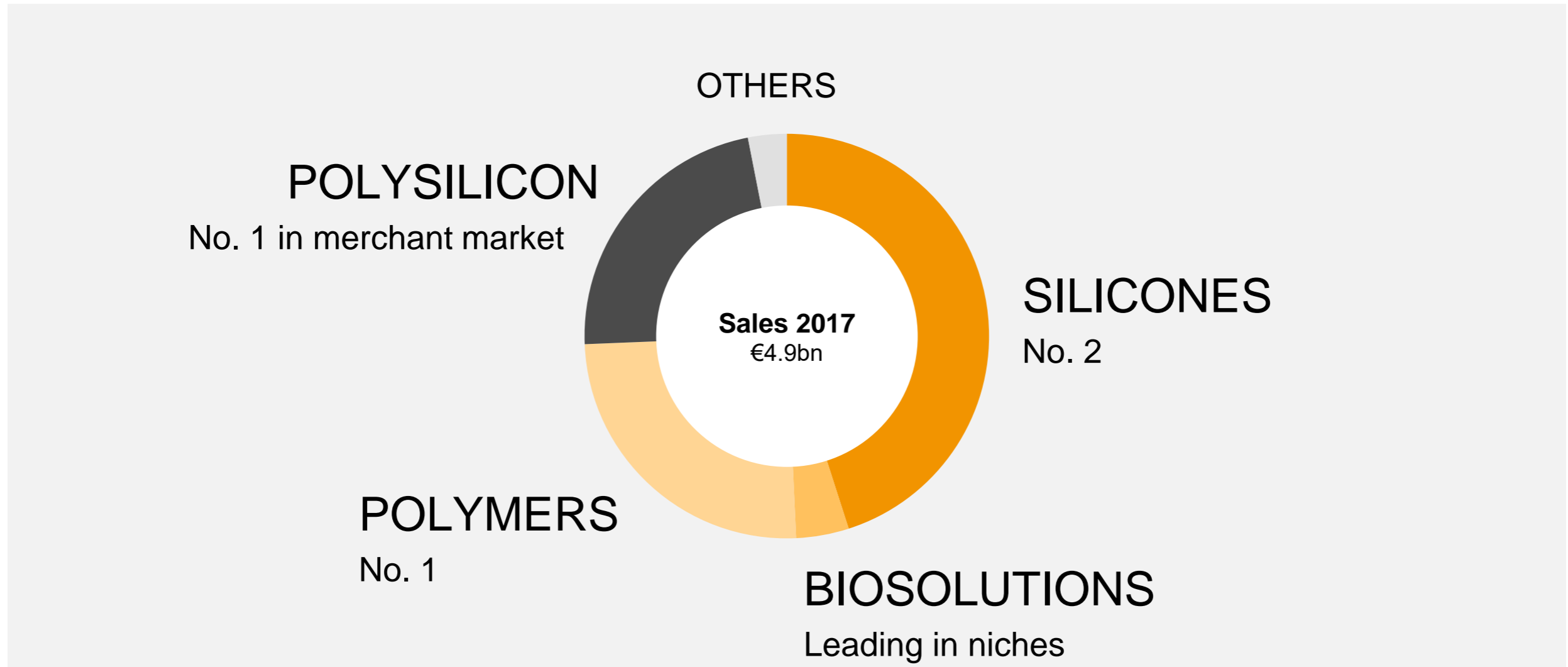

# Effects of Siltronic Deconsolidation: Chemicals with Higher Share

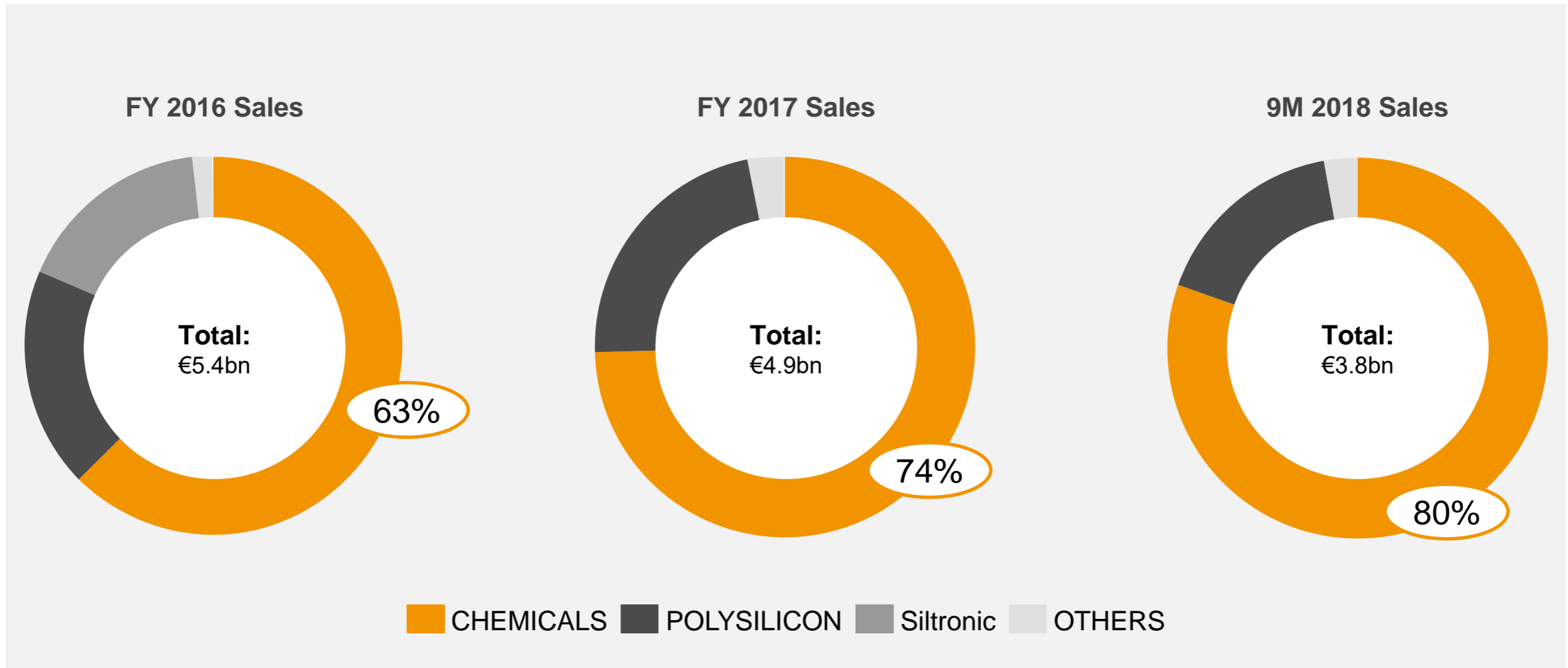

# Solid and Steady Growth Driven By Chemicals

## Development of Sales (€bn) – Chemicals Divisions

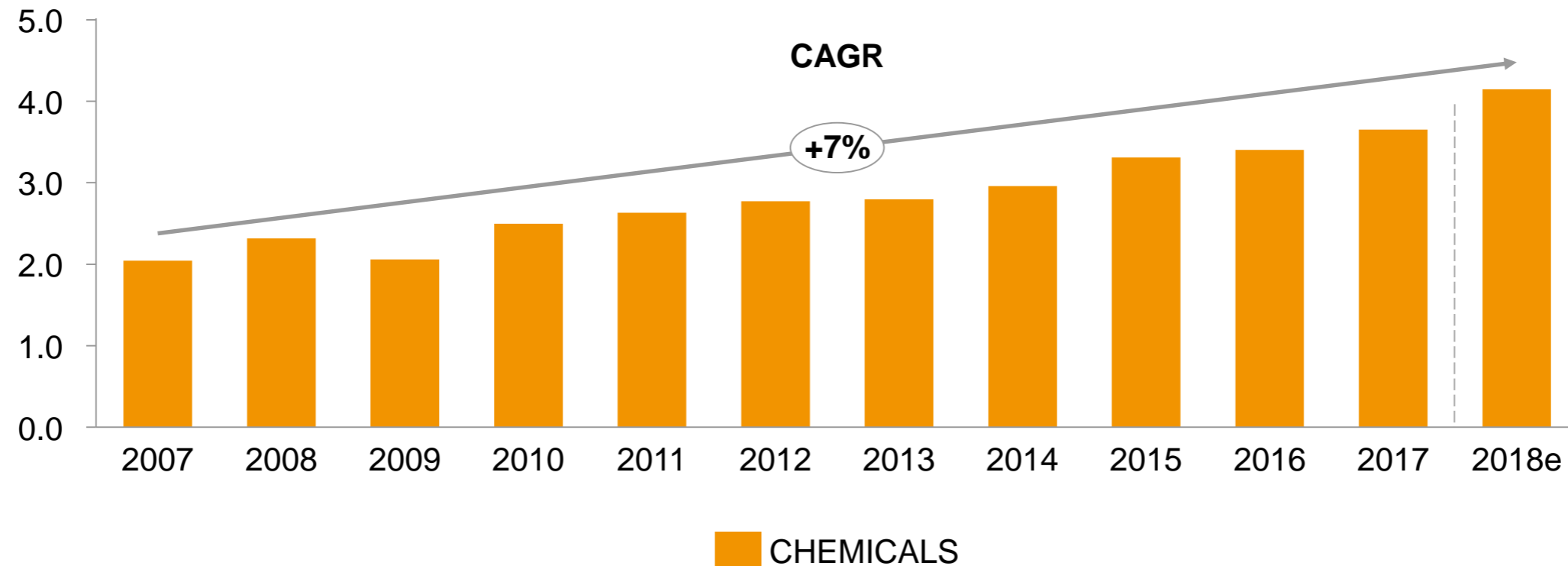

# POLYSILICON on Top of it with Expanded Capacities

## Development of Sales (€bn) – Chemicals Divisions and POLYSILICON

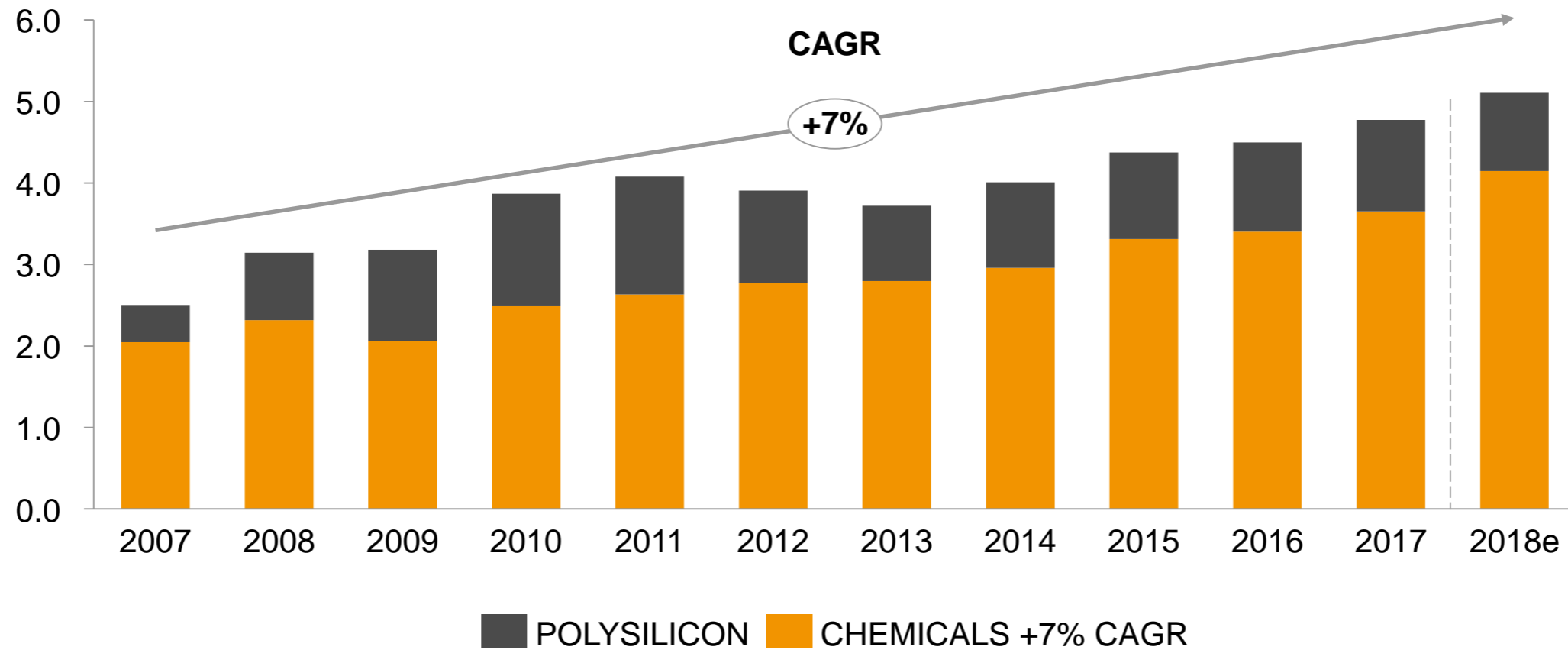

# Target: Leverage Phase Extended with Investment Focus on Chemicals

## CapEx vs. Depreciation Expense WACKER Group w/o Siltronic (€m)

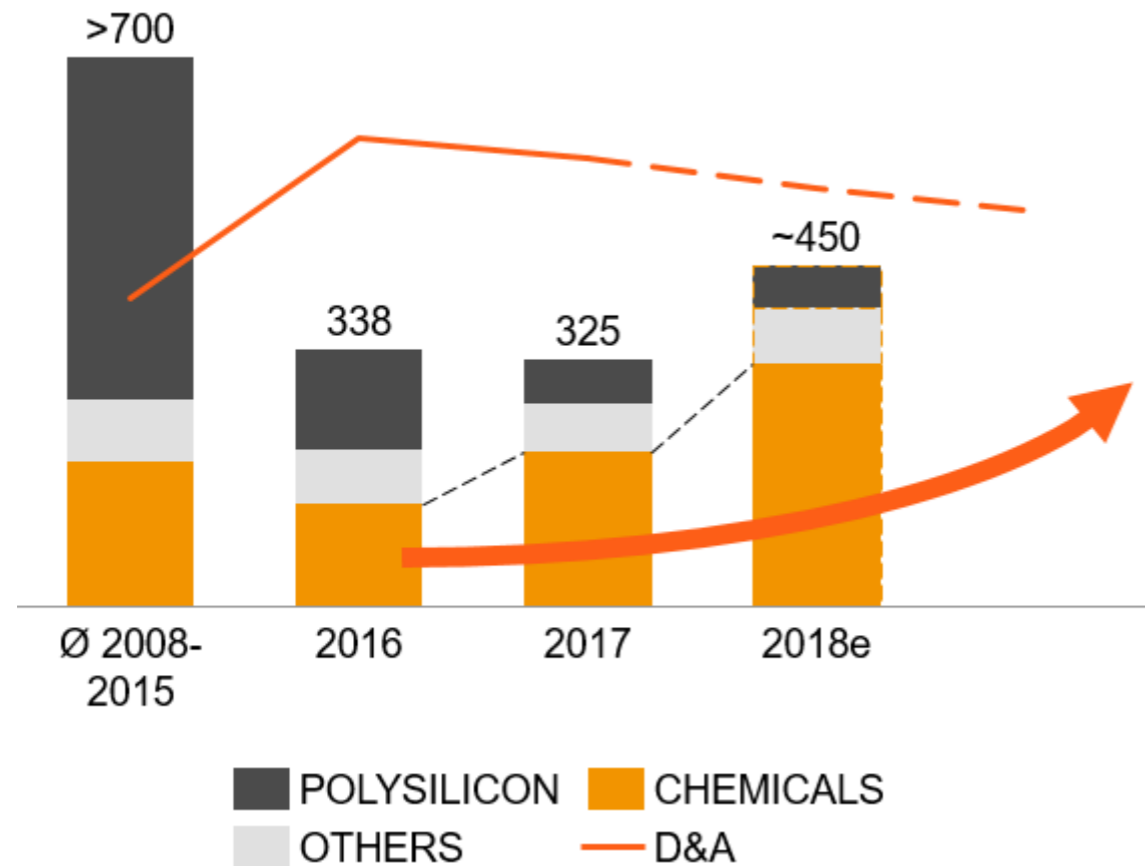

### Leverage Phase:

Group **CapEx < Depreciation**

Clear investment focus  
on **Chemicals**

# The “Magic of Silicon Chemistry” – Structural Variety as a Formula for Success

## Silicone Fundamentals

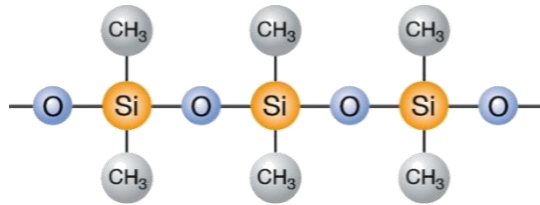

**Non organic** silicon-oxygen (Si-O) backbone chain with **organic side groups** (CH<sub>3</sub>)

### Extremely Stable

- ▶ Si-O molecule with very **high bonding energy**

### Extremely Versatile

- ▶ **Multiple ways to modify** structure, side groups and chain length

## Building Blocks

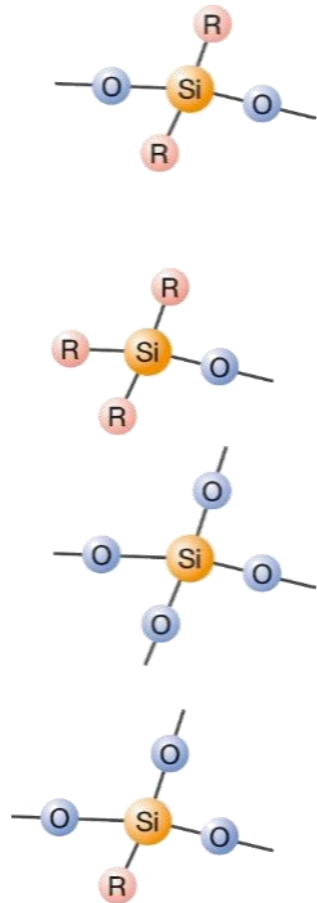

## Silicones Examples

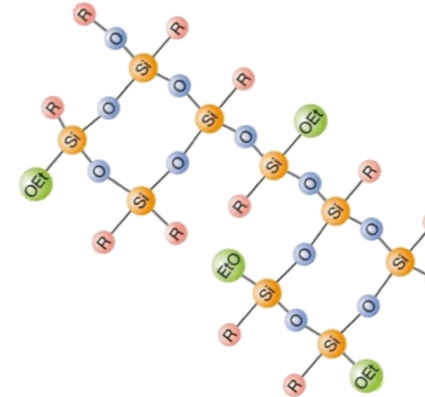

**Resins**

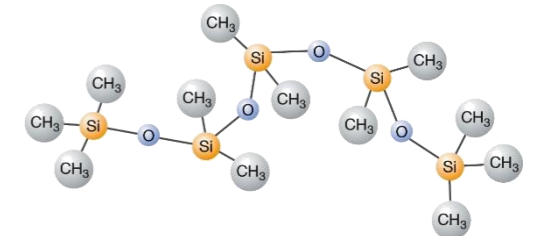

**Fluids**

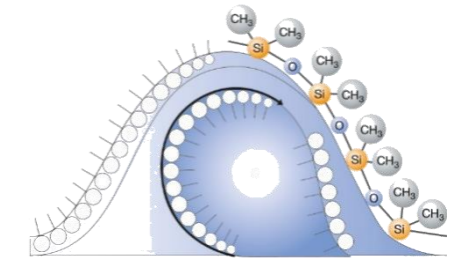

**Antifoam agents**

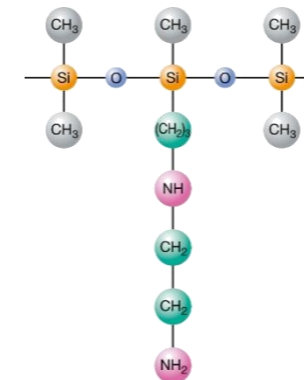

**Textile finishes**

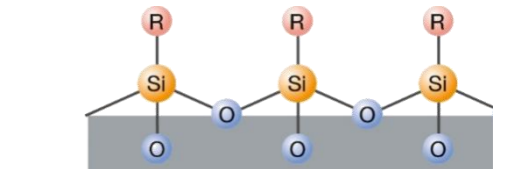

**Masonry protection agents**



# Silicon Chemistry – A Basis for Unlimited Applications

## Broad Spectrum of Adjustable Properties

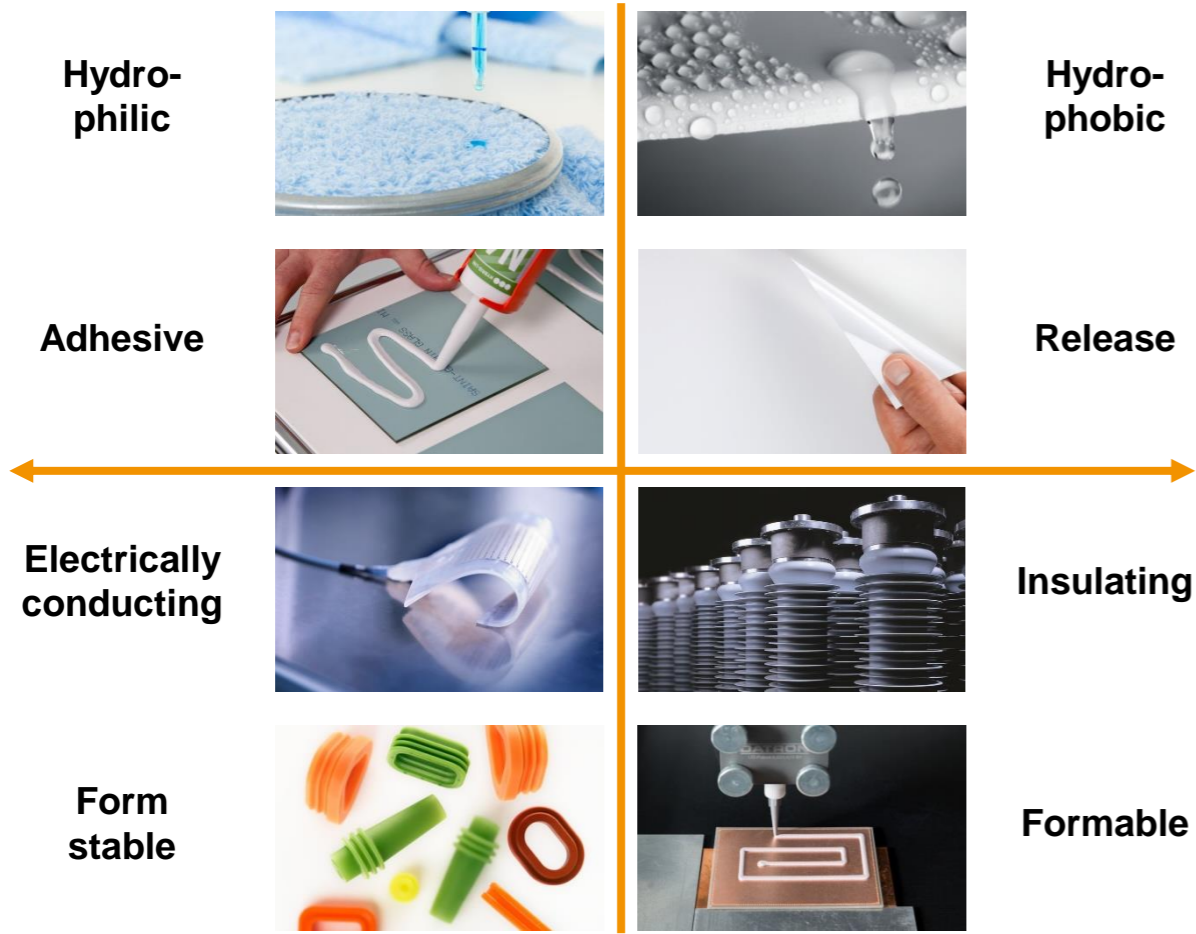

## Customized Products with Unique Properties

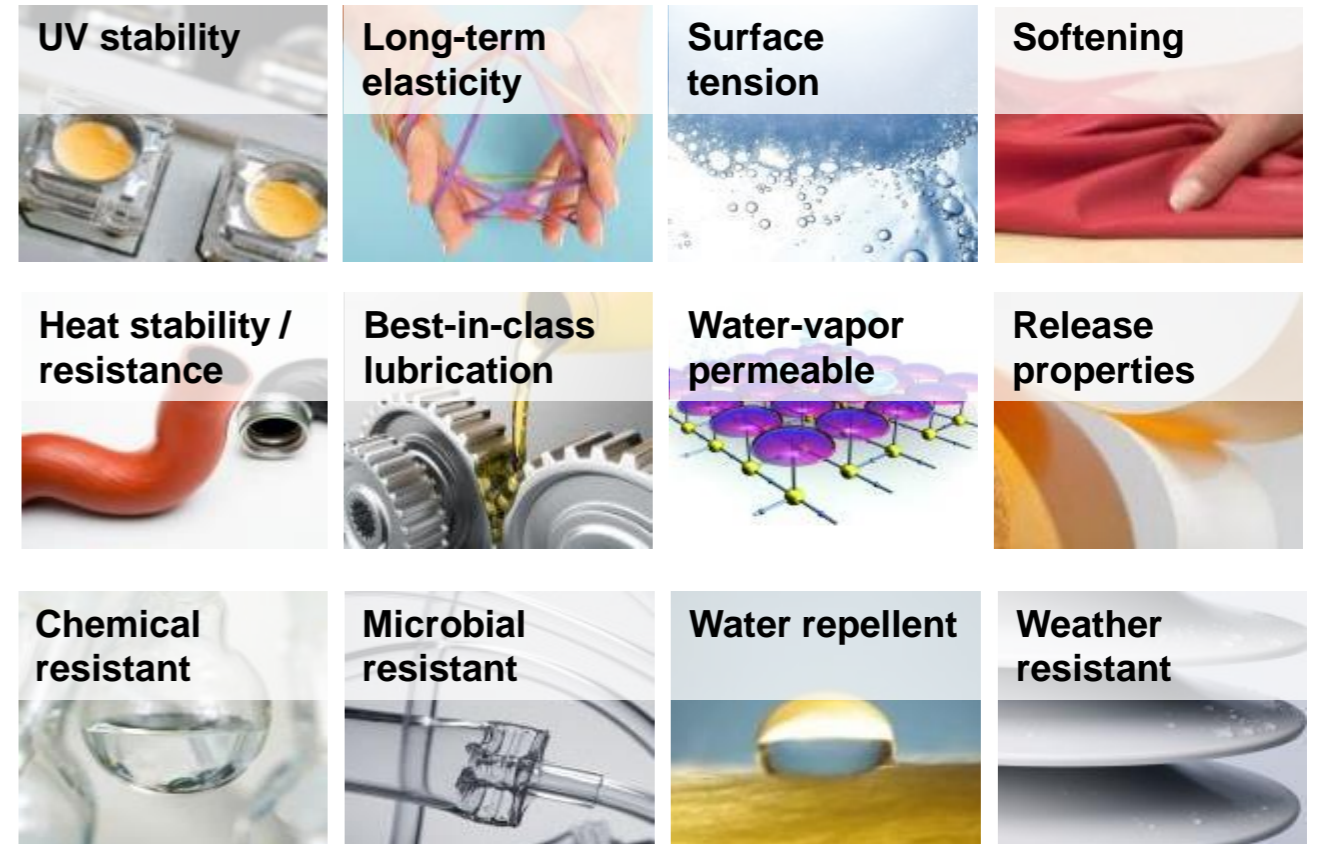

# Silicones Create Value in Many Industries

## Market Structure by Application

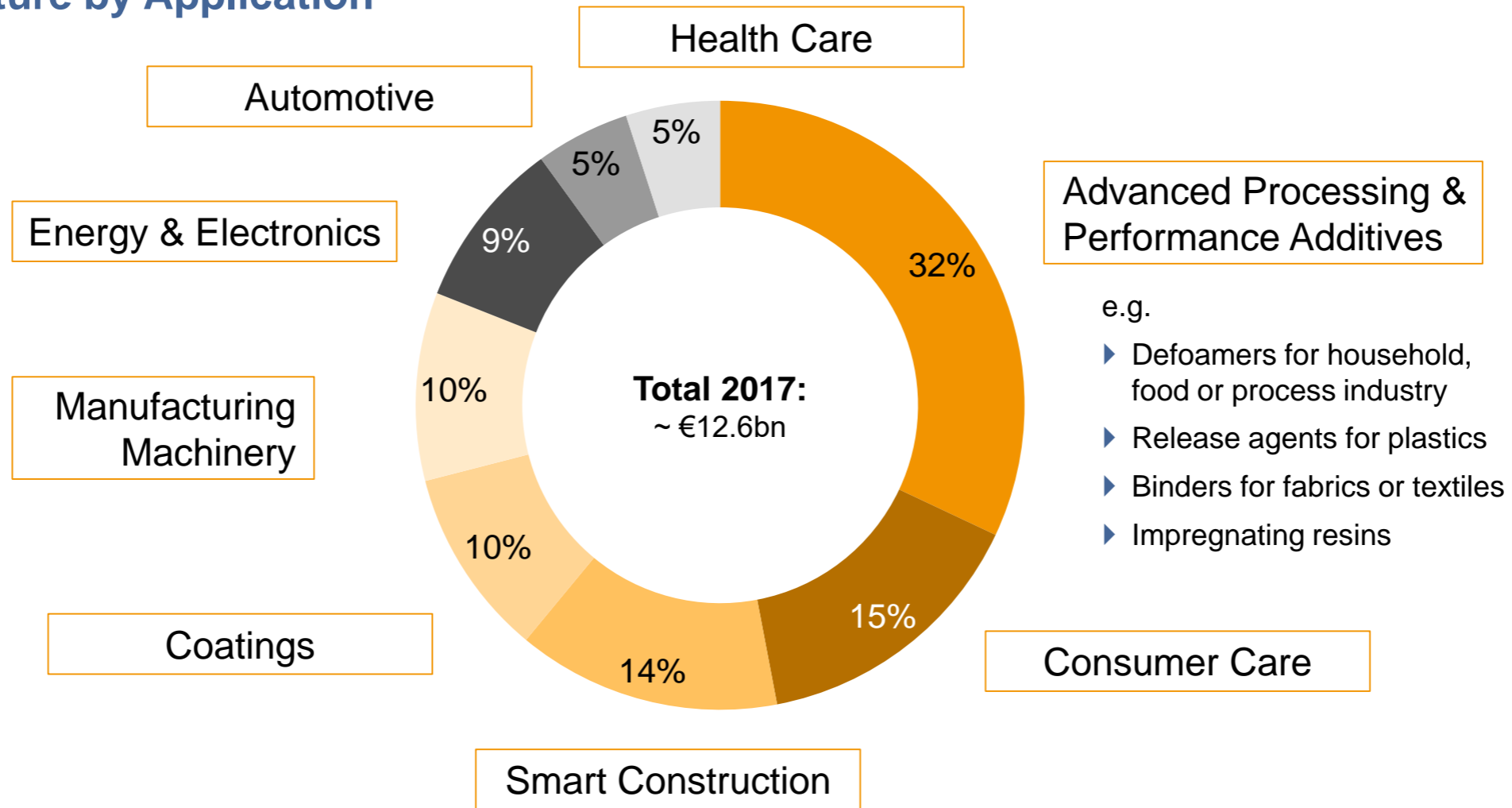

Industry Spilt; Source: Freedonia, Company Reports, WACKER Estimate

# Improved Performance Opens Up Broader Markets for Specialties



# Break-Through Innovations Create New Markets for Specialties

## Thermal Interface Materials

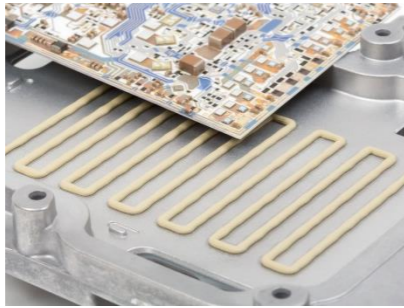

- ▶ Electronics
- ▶ Batteries
- ▶ Sensors

## Novel Silicone Resins

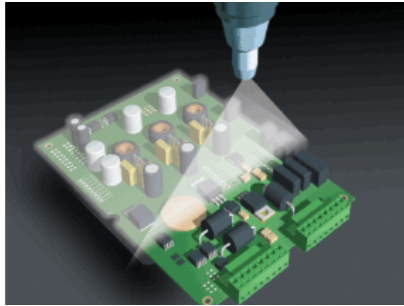

- ▶ Electrical Insulation
- ▶ High-Toughness Resins
- ▶ Binders for Composites

## Adhesives



- ▶ Medical Adhesives
- ▶ Pressure Sensitive Adhesives for Electronics
- ▶ UV-Cure

## New Business Fields



- ▶ 3D Printing

- ▶ Electroactive Silicones



- ▶ Reinforced Concrete

# WACKER with Highest Level of Integration in the Industry

## Open Loop Silicones & Poly Production

### Competitor Processes

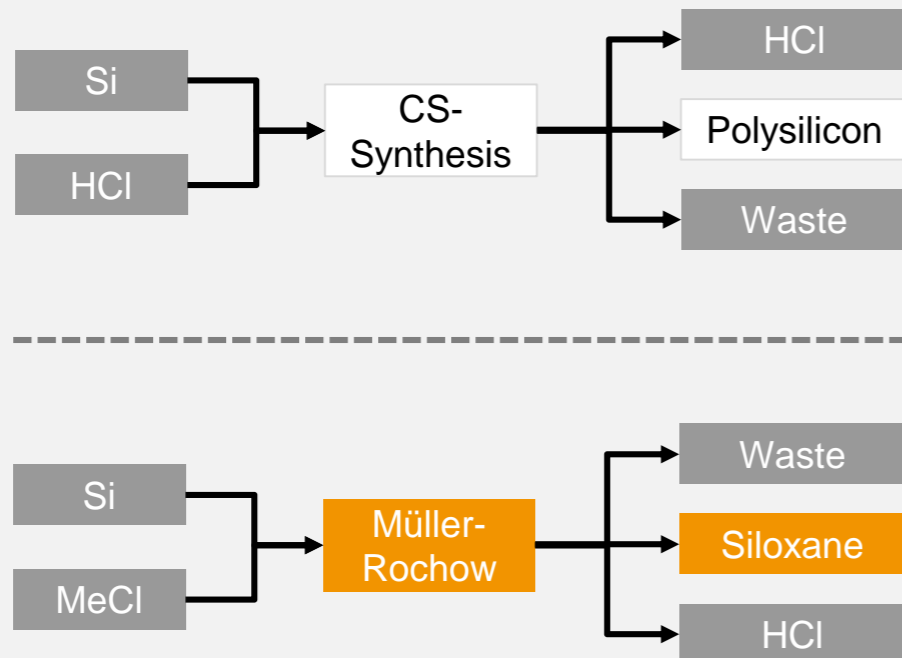

## Unique Silane-Silicone-Silica Loop

### WACKER

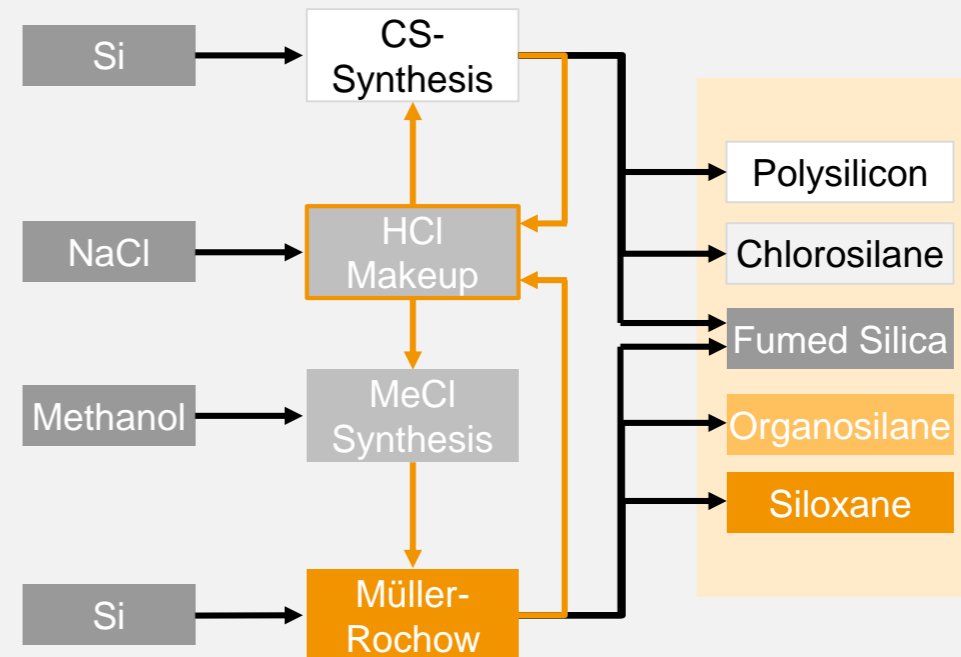

# “WACKER Silicon Verbund” Enables Highly Competitive Cost Position

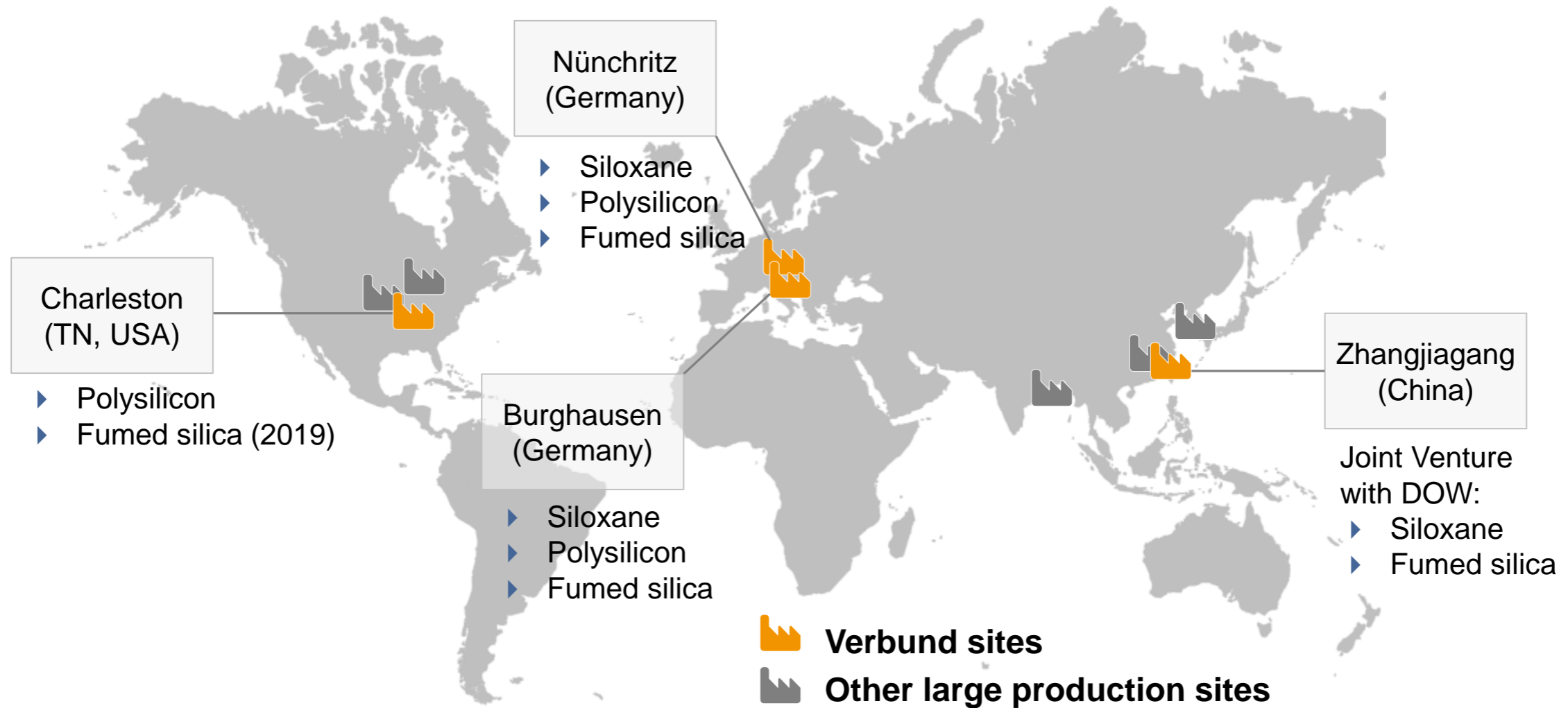

# Operational Excellence is Key

## Siloxane

Index 2012 = 100%

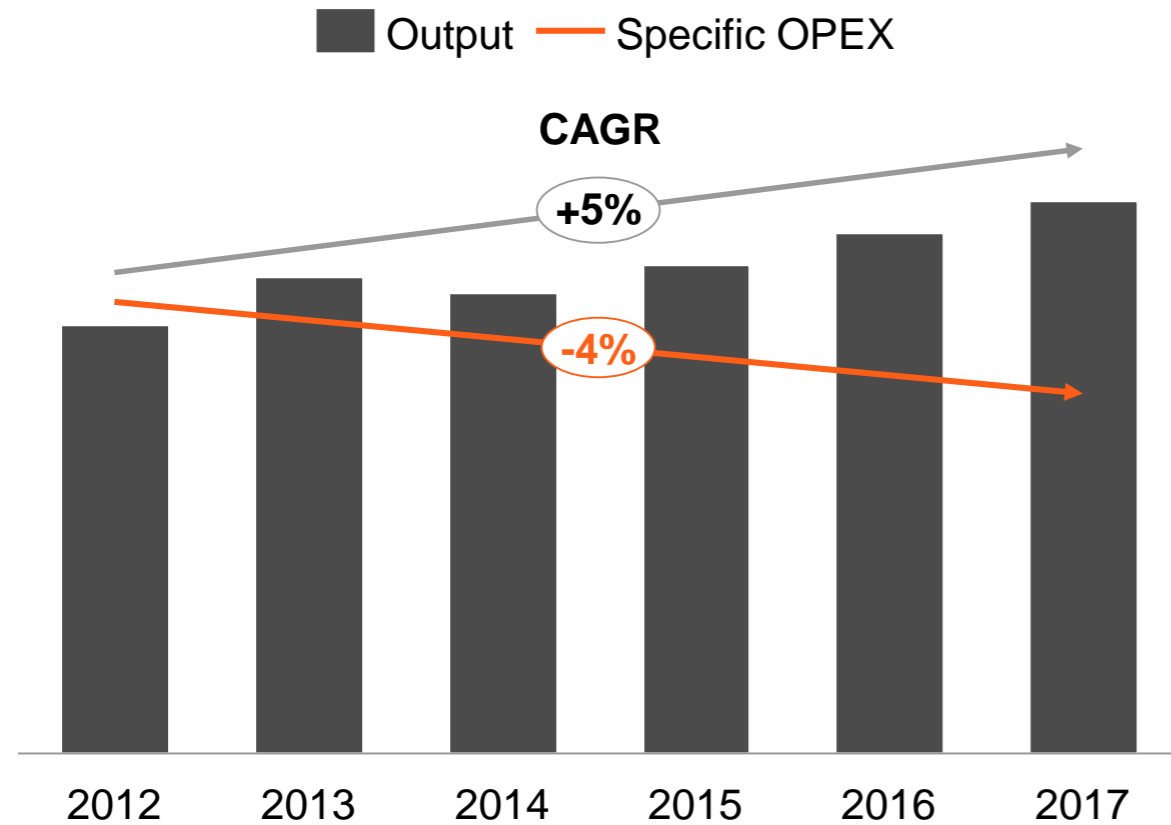

## Fumed Silica

Index 2012 = 100%

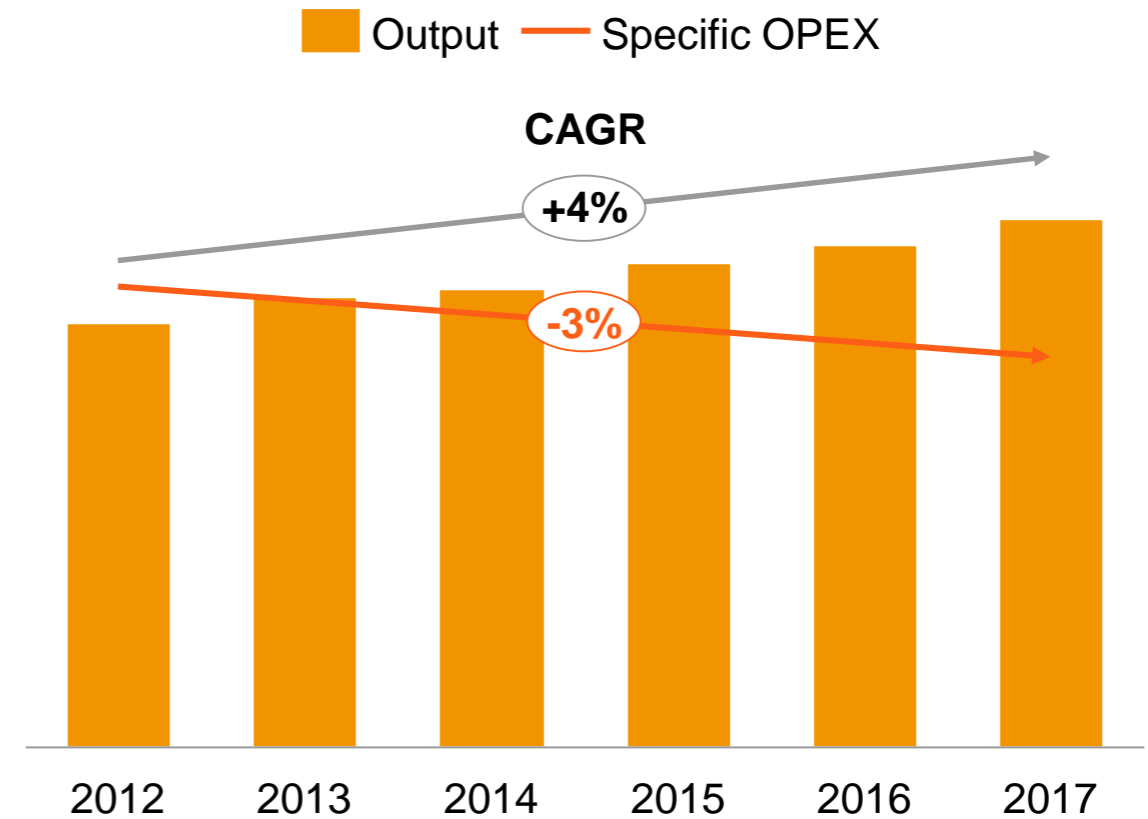

# SILICONES: Strong Chemistry, Innovation Potential and Set Up



## A World of Unlimited Potential

**High  
performance  
products for  
future growth  
markets**



## Innovative Specialty Portfolio

**Growth  
with focus on  
specialties**



## Unique Silicon Verbund

**Full portfolio  
provider with  
benchmark costs**



# SILICONES: Strong Growth Trajectory

Development of WACKER SILICONES Revenue (€bn)

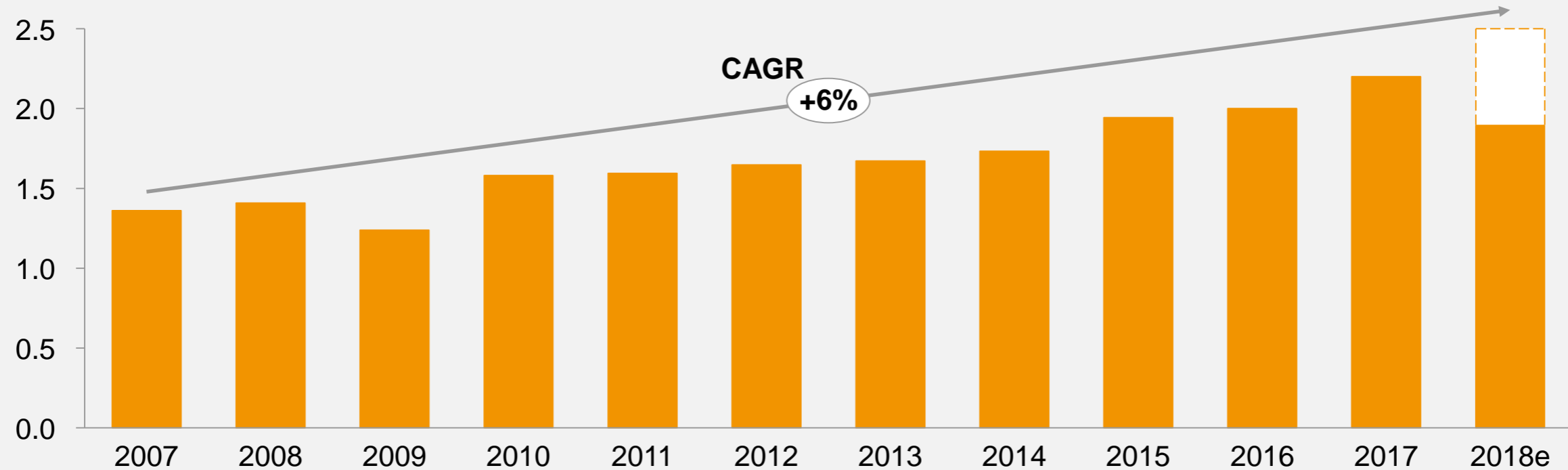

# SILICONES: Investing Into the Future

WACKER Group CapEx (€m)

Group D&A (€m)

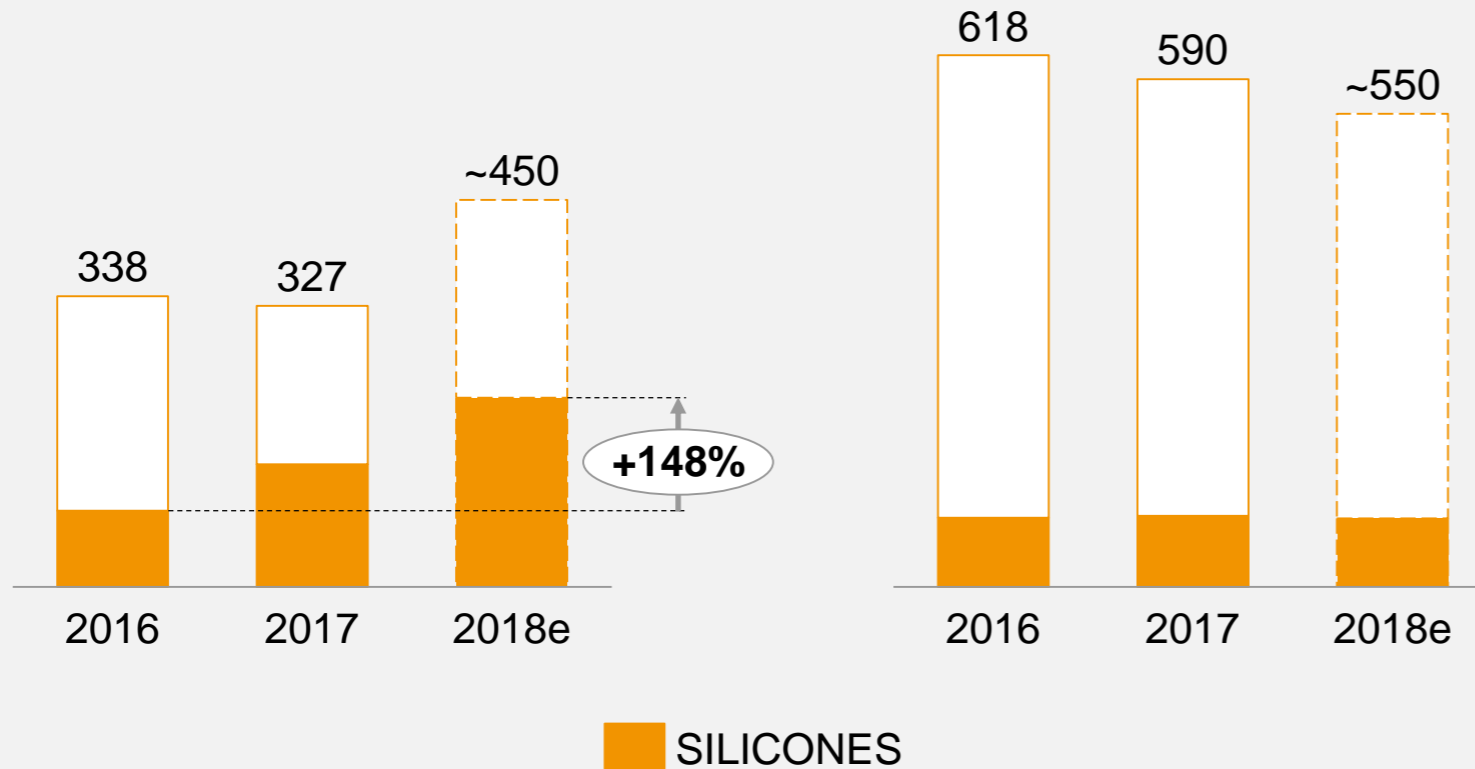

## Challenges:

- Payback <5 years
- Complex engineering

# WACKER Group Highlights 9M 2018

## Financials



€3.8bn

Sales (+1% yoy)

€757m

EBITDA (-3% yoy)

€637m

Net financial debt  
after €224m dividend payout in Q2

## Operations



Good Performance

Price and product mix drive earnings growth, but higher raw material prices yoy

Strong Operations

High utilization in Chemicals, POLYSILICON with lower sales and ramp costs in the USA

Solid performance in  
**9M 2018.**

Strong growth in  
**SILICONES** continues

# WACKER Group Guidance FY 2018

In €m	FY 2017	Outlook 2018
Sales	4,924	Low-single-digit % increase
EBITDA	1,014	Mid-single-digit % increase
EBITDA margin (%)	20.6	Slightly higher than a year ago
Net cash flow	358	Clearly positive, substantially below last year's figure
CapEx	327	Around 450
Net financial debt	454	About 500
Income from continuing operations	250	Substantially higher than last year
Depreciation	590	Around 550
ROCE (%)	7.5	Substantially above the prior-year level
Tax Rate (cont. operations) (%)	25.3	Stable

# WACKER: Issuer, Contact and Additional Information

## Issuer and Contact

### INVESTOR RELATIONS CONTACTS

**Joerg Hoffmann, CFA**

Tel. +49 89 6279 1633  
joerg.hoffmann@wacker.com

**Scott McCollister**

Tel. +49 89 6279 1560  
scott.mccollister@wacker.com

**Monika Stadler**

Tel. +49 89 6279 2769  
monika.stadler.IR@wacker.com

**Wacker Chemie AG**  
Hanns-Seidel-Platz 4  
D-81737 Munich

## Financial Calendar

**03/19/19**

FY 2018 Results

**04/25/19**

Q1 Results 2019

**05/23/19**

Annual Shareholders' Meeting

**08/01/19**

Q2 Results 2019

**10/24/19**

Q3 Results 2019

## Additional Information

**ISIN**

DE000WCH8881

**Deutsche Börse**

WCH

**WKN**

WCH888

## Publications



CUSTOMER  
MAGAZINE



FACTBOOK

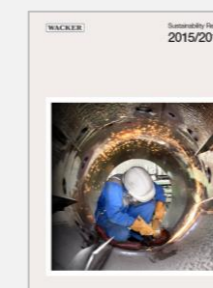

SUSTAINABILITY  
REPORT



SQUARE  
APP